

KEROS ACTUAL

2023



KEROS ACTUAL 2023

ÍNDICE

ÍNDICE	
PACKING	02
ICONOGRAFÍA	04
GREENCARE	05
PORCELÁNICO	05
REVESTIMIENTO	06
CARACTERÍSTICAS TÉCNICAS	148
DESTONIFICADO	150
RESERVA DE DERECHO	149
PIEZAS ESPECIALES	150
ANTIDESLIZANTE	152
LIMPIEZA Y MANTENIMIENTO	155
CONSEJOS COLOCACIÓN	156
COLOCACIONES DE LA SERIE MODULA	158
COLOCACIONES DE LA SERIE TANGRAM	159

PORCELÁNICO

60X120CM/23.6"X47.2"	
ARDENZA	08
LIVORNO	10
ÓNICE	12
MARQUINA	14
BONN	16
FERRARA	18

80X80CM/31.5"X31.5"	
ARDENZA	20
BONN	22
CANADA	24
COTTO	26
DAFNE	28
HALIFAX	30
LONDON	32
QUEBEC	34
REGINA	34
VERNAZZA	36

23X120CM/9"X47.2"	
BANAK	38
HAYEDO	40
SIA	42
TRIBECA	44

MODULA	
ABADÍA	46
ARTESA	48
AUGUSTA	50
CAMBRIDGE	52
PORTOBELLO	54

TANGRAM	
ABADÍA	56
ARTESA	58

30X60CM/11.8"X23.6"	
AUGUSTA	60
BIERZO	62
CAMBRIDGE	64
NEW YORK	66
PORTOBELLO	68
REDSTONE	70
SUNROCK	72

50X50CM/19.7"X19.7"	
ABADÍA	74
ARTESA	76
AUGUSTA	78
CAMBRIDGE	80
PORTOBELLO	68

33X33CM/13.0"X13.0"	
ARES	82
NEW YORK	66
REDSTONE	70
PELDAÑOS	92
33X33CM/13.0"X13.0"-GREENCARE	
ABADÍA	84
MURTA	86

23X46CM / 9.1"X18.1"	
PIEDRA	88
ROCK	90

PELDAÑOS	
ABADÍA	92
ARES	92
CAMBRIDGE	92
NEW YORK	92
REDSTONE	92
POTOBELLO	92

REVESTIMIENTO

40X120CM/ 15.75"X47.24"	
AGORA	96
SUPERWHITE	100
TREND	102

30X90CM/11.8"X25.4"	
ARDENZA	104
CORINTO	106
EXPRESSION	108
LIVORNO	110
LONDON	112
PEONÍA	114
TARENTO	116
TEBAS	118
THAMES	120
VERNAZZA	122
WHITE	124

25X75CM/9.8"X29.5"	
CARTAGO	126
CITY	128
WHITE	130

30X60CM/11.8"X23.6"	
ALMA	132
ARDENZA	134
BLANCOS	140
LONDON	136
NATURA	138
SOUL	132

20X50CM/7.87"X19.7"	
BLANCOS	140
LAND	142
NATURA	144
VERNAZZA	146

◆ PACKING ◆

PORCELÁNICO

	PZAS/CJ	M ² /CJ	KG/CJ	PALET	CJ/PALET	M ² /PALET	KG/PALET
	PC/BOX	M ² /BOX	KG/CJ	PALLET	BOX/PALET	M ² /PALLET	KG/PALLET
100X100 MODULA	8	1.00	21.53	108X108 80X120 EUROPALLET	44 34	44.00 34.00	959 754
100X100 TANGRAM	21	1.00	21.53	- -	- -	- -	- -
80X80	2	1.28	29.71	93X113 80X120 EUROPALLET	40 35	51.20 44.80	1203 1062
60X120	3	1.50	33.20	120X108 80X120 EUROPALLET	32 24	48.00 36.00	1080 820
50X50	6	1.50	32.40	95X95 80X120 EUROPALLET	48 24	72.00 36.00	1560 805
30X60	7	1.26	24.50	108X108 80X120 EUROPALLET	48 40	60.48 50.4	1176 980
33X67 REDSTONE	7	1.55	30.10	110X110	48	74.40	14V58
33X33	14	1.55	28.00	100X100 80X120 EUROPALLET	44 42	68.20 65.10	1244 1177
33X33 GREEN CARE	16	1.77	26.55	100X100	44	77.88	1180
23X120	?	?	?	108X120 80X120 EUROPALLET	?	?	?
23X120R	?	?	?	108X120	?	?	?

** RODAPIE / SKIRTING

	CÓDIGO	PZAS/CJ
	CODE	PC/BOX
RODAPIE ¿? (23X120)	?	?
RODAPIE 8X33	P050	17
RODAPIE 8X67	P095	17
RODAPIE 8X80	P135	16

PIEZAS ESPECIALES / SPECIAL PIECES

	PIEZA	PZAS/CJ
	PIECE	PC/BOX
30X30 (5X5)	MOSAICOS*	12
1X100	LISTELO METAL	10

REVESTIMIENTO / WALL TILES

	PZAS/CJ	M ² /CJ	KG/CJ	PALET	CJ/PALET	M ² /PALET	KG/PALET
	PC/BOX	M ² /BOX	KG/CJ	PALLET	BOX/PALET	M ² /PALLET	KG/PALLET
40X120	3	1.44	28.00	80X120 EUROPALLET	20	28.80	580.80
30X90	5	1.35	25.12	120X95 80X120 EUROPALLET	54 24	72.90 32.40	1374 625
30X60	8	1.44	26.12	103X103 80X120 EUROPALLET	48 32	69.12 46.10	1266 870
25X75	8	1.50	27.19	108X108 80X120 EUROPALLET	48 36	72.00 54.00	1323 1001
20X50	10	1.00	16.40	108X108 80X120 EUROPALLET	80 70	80.00 70.00	1324 1160

*Mosaicos 30x30 (5x5) cm disponibles en todos los productos bajo petición.
Mosaics 30x30 (5x5) cm available to all the products on demand.

**Rodapie disponibles en todos los productos bajo petición.
Skirting available to all the products on demand.

• ICONOGRAFÍA •

TIPO DE SUPERFICIE
TYPE OF SURFACE



PAVIMENTO
FLOOR TILE



REVESTIMIENTO
WALL TILE



POLIVALENTE
FLOOR & WALL TILE

ACABADOS
FINISHES



BRILLO
SHINE



MATE
MATT



BRILLO GRANILLA
GRANILLE SHINE



BRILLO PULIDO
POLISHED SHINE

MATERIAL
MATERIAL



PORCELÁNICO
PORCELANICO



GRES



PASTA BLANCA
WHITE BODY



PASTA ROJA
RED BODY

DESTONIFICACIÓN
SHADE VARIATION



VARIACIÓN LIGERA.
SLIGHT VARIATION.



VARIACIÓN MODERADA.
MODERATE VARIATION.



VARIACIÓN SUBSTANCIAL.
SUBSTANTIAL VARIATION.

COLOCACIÓN
TILE-LAYING



TRABADO MENOR A 20%
INTERLOCKED LAYING
MAXIMUM 20%



JUNTA 3mm
JOINT 3mm

CARACTERÍSTICAS TÉCNICAS
TECHNICAL CHARACTERISTICS



ANTIHELO
ANTIFROST



ANTIDESLIZANTE
ANTISLIP



RECTIFICADO
RECTIFIED



RELIEVE
RELIEF



GREENCARE
(ESPOSOR 7MM / SPESSORE 7MM)

• GREENCARE •



GREENCARE by Keros

Es un nuevo programa de desarrollo con el que se quiere reducir el impacto en el medio ambiente. Está creado para generar menos cantidad de emisiones y así obtener un producto ambientalmente responsable.

Una de las características principales es su reducción de espesor, con esto conseguimos una mejor eficiencia energética a la hora de su producción y un menor consumo de materias primas. Gracias a la utilización de aditivos especiales sigue conservando sus características técnicas. Así mismo, al reducir el peso de la pieza, se aumenta la cantidad de metros transportados, con lo que, de nuevo, se reducen emisiones, en este caso, del transporte.

Desde Keros apostamos por la filosofía del ECODISEÑO, basada en crear productos sostenibles, que minimicen el impacto ambiental durante todo el ciclo de vida del producto desde su diseño propiamente dicho, hasta la producción, utilización y retirada.

GREENCARE by Keros

Est un produit créé pour réduire l'impact sur l'environnement. Il est pensé pour générer moins d'émissions et ainsi obtenir un produit plus respectueux avec l'environnement.

L'une des principales caractéristiques est la réduction de l'épaisseur, ce qui nous permet d'obtenir une meilleure efficacité énergétique lors de la production et une consommation réduite de matières premières. Grâce à l'utilisation d'additifs spéciaux, il conserve intacte toutes ses caractéristiques techniques. De même, en réduisant le poids de la pièce, le nombre de mètres transportés est augmenté, ce qui réduit les émissions, dans ce cas, du transport.

Chez Keros, nous nous engageons à respecter la philosophie ECODÉSIGN, basée sur la création de produits durables qui minimisent l'impact environnemental tout au long du cycle de vie du produit, de sa conception à sa production, son utilisation et son retrait.

GREENCARE by Keros

Is a new program in which we want to reduce the environmental impact on our planet. GREENCARE has been created to decrease our emissions, producing in the end an environmentally responsible product.

One of the main key features and benefits of GREENCARE is the reduction of the material thickness. This will provide better energy efficiency during production, and a reduction in raw materials, but will not compromise on our KEROS quality product. Thanks to our research and development of GREENCARE our new products will keep all of its technical specifications. However, an added bonus due to the reduction of weight, we can increase the quantity of square metres during transport. This will significantly reduce transport cost, but more importantly add to the reduction of transport emissions.

At Keros we are committed to the ECODISEÑO philosophy, based on creating sustainable products that minimize the environmental impact across the product life cycle from the design, production, use and recycling.

PORCELÁNICO

PORCELANICO

Más información en nuestra web: www.keros.com / For more information: www.keros.com

60X120CM/23,6"X47,2"	
ARDENZA	08
LIVORNO	10
ÓNICE	12
MARQUINA	14
BONN	16
FERRARA	18
80X80CM/31,5"X31,5"	
ARDENZA	20
BONN	22
CANADA	24
COTTO	26
DAFNE	28
HALIFAX	30
LONDON	32
QUEBEC	34
REGINA	34
VERNAZZA	36
23X120CM/9"X47,2"	
BANAK	38
HAYEDO	40
SIA	42
TRIBECA	44
MODULA	
ABADÍA	46
ARTESA	48
AUGUSTA	50
CAMBRIDGE	52
PORTOBELLO	54

TANGRAM	
ABADÍA	56
ARTESA	58
30X60CM/11,8"X23,6"	
AUGUSTA	60
BIERZO	62
CAMBRIDGE	64
NEW YORK	66
PORTOBELLO	68
REDSTONE	70
SUNROCK	72
50X50CM/19,7"X19,7"	
ABADÍA	74
ARTESA	76
AUGUSTA	78
CAMBRIDGE	80
PORTOBELLO	68
33X33CM/13,0"X13,0"	
ARES	82
NEW YORK	64
REDSTONE	70
PELDAÑOS	92
33X33CM SLIM/13,0"X13,0" SLIM	
ABADÍA	84
MURTA	86
23X46CM / 9,1"X18,1"	
PIEDRA	88
ROCK	90

PORCELÁNICO RECTIFICADO



| Ardenza Gold 60x120

ARDENZA

60x120 cm / 23,6"x47,2"



Ardenza Gold
60x120 cm

M175

PORCELÁNICO RECTIFICADO



| Livono Gris 60x120 cm |

LIVORNO

60x120 cm / 23,6"x47,2"



Livorno Gris
60x120 cm

M175

PORCELÁNICO RECTIFICADO



| Ónice Silver 60x120 cm |

ONICE

60x120 cm / 23,6"x47,2"



Ónice Silver
60x120 cm

M175

PORCELÁNICO RECTIFICADO



| Marquina Negro 60x120 cm |

MARQUINA

60x120 cm / 23,6"x47,2"

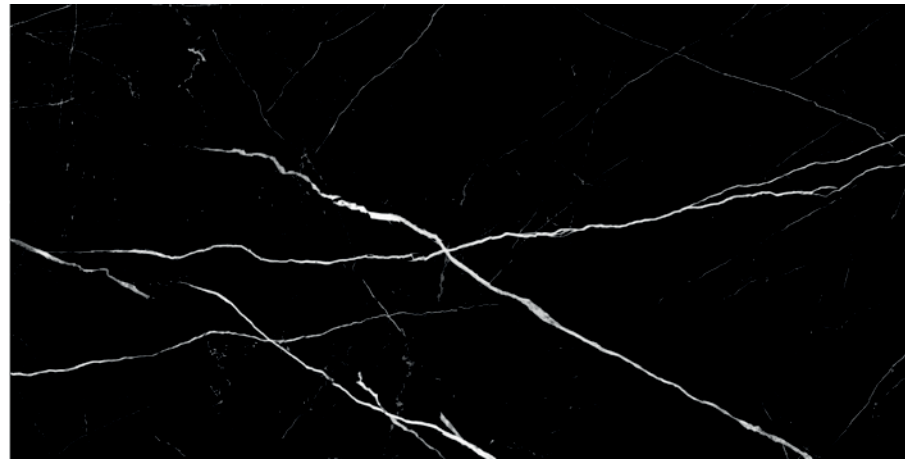

Marquina Negro
60x120 cm

M175

PORCELÁNICO RECTIFICADO



| Bonn Gris 60x120 cm |

BONN

60x120 cm / 23,6"x47,2"



Bonn Gris
60x120 cm

M176



Bonn Acero
60x120 cm

M176

PORCELÁNICO RECTIFICADO



| Ferrara Beige 60x120 cm |

FERRARA

60x120 cm / 23,6"x47,2"



Ferrara Gris
60x120 cm

M176



Ferrara Beige
60x120 cm

M176

PORCELÁNICO RECTIFICADO



| Ardenza Mate 80x80 cm |

ARDENZA

80x80 cm / 31,5"x31,5"



Ardenza Brillo
80x80 cm

A090



Ardenza Mate
80x80 cm

A091

PORCELÁNICO RECTIFICADO



| Bonn Gris 80x80 cm |

BONN

80x80 cm / 31,5"x31,5"

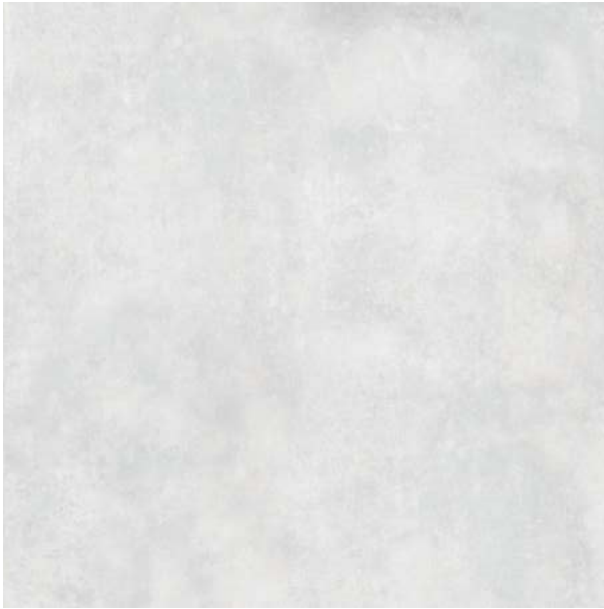

Bonn Gris
80x80 cm

A091



Bonn Acero
80x80 cm

A091



Bonn Beige
80x80 cm

A091

PORCELÁNICO RECTIFICADO



| Canada Roble 80x80 cm |

CANADA

80x80 cm / 31,5"x31,5"



Canada Roble
80x80 cm

A091

5 diseños diferentes / 5 different designs

PORCELÁNICO RECTIFICADO



| Cotto Beige Antislip 80x80 cm | Cotto Beige 80x80 cm |

COTTO

80x80 cm / 31,5"x31,5"

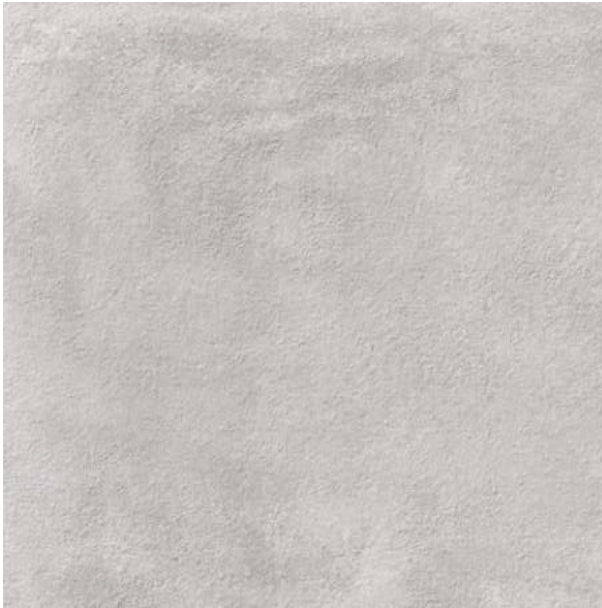

Cotto Gris
80x80 cm
80x80 cm · Antislip

A091
A097



Cotto Acero
80x80 cm

A091

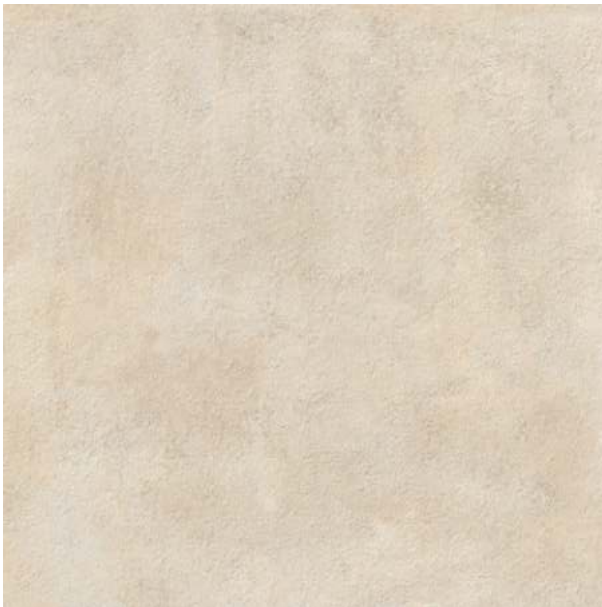

Cotto Beige
80x80 cm
80x80 cm · Antislip

A091
A097



Cotto Cuero
80x80 cm

A091

PORCELÁNICO RECTIFICADO



| Dafne Negro 80x80 cm |

DAFNE

80x80 cm / 31,5"x31,5"



Dafne Gris
80x80 cm

A091



Dafne Negro
80x80 cm

A091



Dafne Beige
80x80 cm

A091



Dafne Taupe
80x80 cm

A091

PORCELÁNICO RECTIFICADO



| Halifax 80x80 cm |

HALIFAX

80x80 cm / 31,5"x31,5"



Halifax
80x80 cm

A091

8 diseños diferentes / 8 different designs

PORCELÁNICO RECTIFICADO



| London Gris 80x80 cm |

LONDON

80x80 cm / 31,5"x31,5"

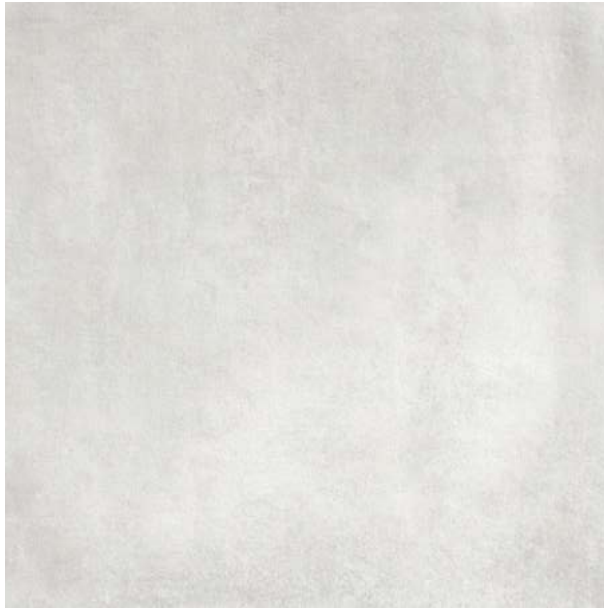

London Gris
80x80 cm

A091

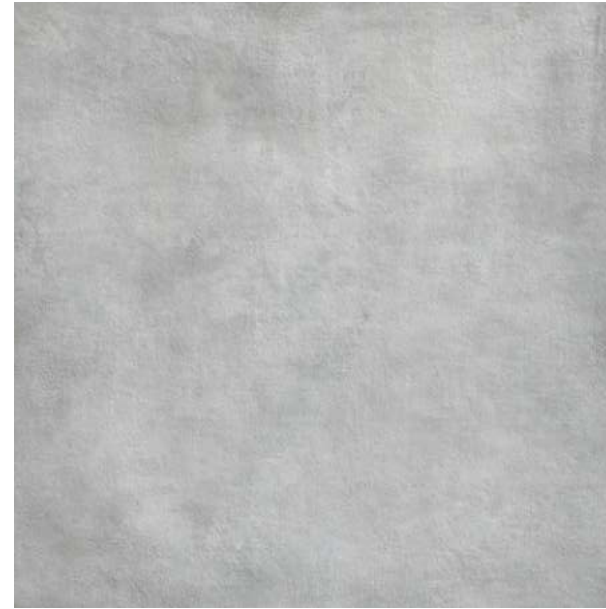

London Acero
80x80 cm

A091

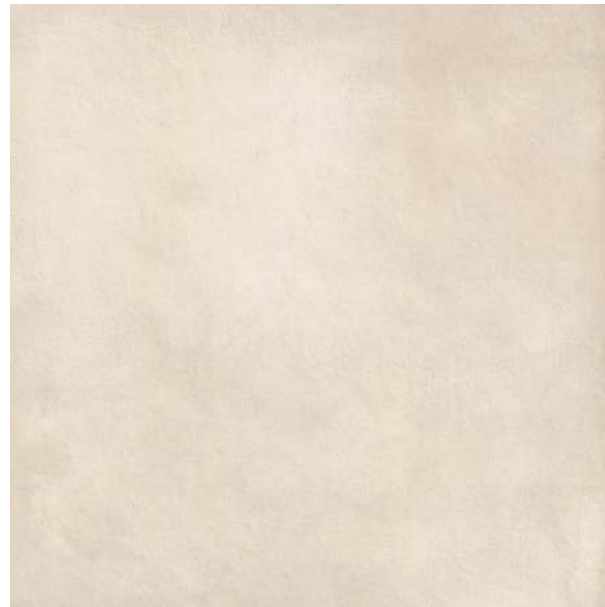

London Beige
80x80 cm

A091

PORCELÁNICO RECTIFICADO



| Quebec 80x80 cm |

QUEBEC

80x80 cm / 31,5"x31,5"



Quebec
80x80 cm

A090

REGINA

80x80 cm / 31,5"x31,5"



Regina
80x80 cm

A091



VERNAZZA

80x80 cm / 31,5"x31,5"



Vernazza Negro
80x80 cm

A091

PORCELÁNICO



| Banak Gris 23x120 cm |

BANAK

23x120 cm / 9"x47,2"



Banak Beige
23x120 cm

M183



Banak Blanco
23x120 cm

M183



Banak Gris
23x120 cm

M183

PORCELÁNICO



| Hayedo Roble - Antislip 23x120 cm | Hayedo Roble 23x120 cm |

HAYEDO

23x120 cm / 9"x47,2"



Hayedo Almond
23x120 cm
23x120 cm-Antislip

M183
M184



Hayedo Roble
23x120 cm
23x120 cm-Antislip

M183
M184



Hayedo Gris
23x120 cm
23x120 cm-Antislip

M183
M184



TAKE ME
TO THE
FJORDS

SIA

23x120 cm / 9"x47,2"



Sia Blanco
23x120 cm

M183



Sia Almond
23x120 cm

M183



Sia Miel
23x120 cm

M183



Sia Oliva
23x120 cm

M183

PORCELÁNICO

Shopping list

- cheese
- milk
- bread
- yoghurt
- dips
- lemon
- wine
- banana
- olive
- veg



TRIBECA

23x120 cm / 9"x47,2"



Tribeca
23x120 cm

M183



MODULA ABADÍA

2pz 50x50 cm, 2pz 25x50 cm, 4pz 25x25 cm
2pc 19,7"x19,7", 2pc 9,8"x19,7" x 4pc 9,8"x9,8"



Modula Abadía Avena
MODULA
MODULA · Antislip

M164
M166



Modula Abadía Centeno
MODULA
MODULA · Antislip

M164
M166

PORCELÁNICO



MODULA ARTESA

2pz 50x50 cm, 2pz 25x50 cm, 4pz 25x25 cm
2pc 19,7"x19,7", 2pc 9,8"x19,7" x 4pc 9,8"x9,8"



Modula Artesa Beige
MODULA
MODULA · Antislip

M164
M166

PORCELÁNICO



| Modula Augusta Beige · Antislip |

MODULA AUGUSTA

2pz 50x50 cm, 2pz 25x50 cm, 4pz 25x25 cm
2pc 19,7"x19,7", 2pc 9,8"x19,7"x 4pc 9,8"x9,8"



Modula Augusta Beige
MODULA
MODULA · Antislip

M164
M166



MODULA CAMBRIDGE

2pz 50x50 cm, 2pz 25x50 cm, 4pz 25x25 cm
2pc 19,7"x19,7", 2pc 9,8"x19,7"x 4pc 9,8"x9,8"



Modula Cambridge Bone
MODULA
MODULA · Antislip

M164
M166



Peldaño Extrusionado Cambridge Bone
33x33 cm · Antislip P260

*Ejemplos de modulos en la pag. 248.
Module examples on the 248.



MODULA PORTOBELLO

2pz 50x50 cm, 2pz 25x50 cm, 4pz 25x25 cm
 2pc 19,7"x19,7", 2pc 9,8"x19,7"x 4pc 9,8"x9,8"



Modula Portobello Ivory
 MODULA
 MODULA · Antislip

M164
 M166



Modula Portobello Taupe
 MODULA
 MODULA · Antislip

M164
 M166



Modula Portobello Silver
 MODULA
 MODULA · Antislip

M164
 M166



Peldaño Extrusionado Portobello Taupe
 33x33 cm · Antislip P260

*Ejemplos de modulos en la pag. 248.
 Module examples on the 248.



TANGRAM ABADÍA

4pz 25x50 cm, 4pz 25x25 cm, 4pz 12x25 cm, 8pz 12x12 cm
4pc 9,8"x19,7", 4pc 9,8"x9,8", 4pc 4,7"x9,8", 8pc 4,7"x4,7"



Tangram Abadía Avena
TANGRAM
TANGRAM · Antislip

M181
M182



Peldaño Extrusionado Abadía Avena
33x33 cm · Antislip P260



TANGRAM ARTESA

4pz 25x50 cm, 4pz 25x25 cm, 4pz 12x25 cm, 8pz 12x12 cm
4pc 9,8"x19,7", 4pc 9,8"x9,8", 4pc 4,7"x9,8", 8pc 4,7"x4,7"



Tangram Artesa Beige
TANGRAM
TANGRAM · Antislip

M181
M182



ABADÍA

50x50 cm / 19,7"x19,7"



Abadía Avena
50x50 cm
50x50 cm · Antislip

M085
M111



Abadía Centeno
50x50 cm
50x50 cm · Antislip

M085
M111

PORCELÁNICO



| Artesa 50x50 cm |

ARTESA

50x50 cm / 19,7"x19,7"



Artesa
50x50 cm
50x50 cm - Antislip

M085
M111

PORCELÁNICO



| Augusta Beige 50x50 cm |

AUGUSTA

50x50 cm / 19,7"x19,7"



Augusta Beige
50x50 cm
50x50 cm · Antislip

M085
M111

PORCELÁNICO



| Cambridge Bone · Antislip 50x50 cm |

CAMBRIDGE

50x50 cm / 19,7"x19,7"



Cambridge Bone
50x50 cm
50x50 cm - Antislip

M085
M111

PORCELANICO



| Portobello Taupe 50x50 cm |

PORTOBELLO

50x50 cm - 19,7"x19,7"



Portobello Ivory
50x50 cm
50x50 cm - Antislip

M085
M111



Portobello Taupe
50x50 cm
50x50 cm - Antislip

M085
M111



Portobello Silver
50x50 cm
50x50 cm - Antislip

M085
M111



Peldaño Extrusionado Portobello Taupe
33x33 cm - Antislip P260

PORCELÁNICO



| Augusta-Beige Antislip 30x60 cm |

AUGUSTA

30x60 cm / 11,8"x23,6"



Augusta Beige
30x60 cm
30x60 cm · Antislip

M185
M185

PORCELÁNICO



Sunrock Blanco 33x67 cm |

SUNROCK

30x60 cm / 11,8"x23,6"



Sunrock Blanco
30x60 cm

M185



Sunrock Negro
30x60 cm

M185



Mosaico Sunrock Blanco
30x30 (5x5) cm P180

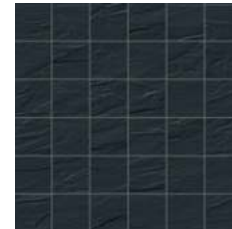

Mosaico Sunrock Negro
30x30 (5x5) cm P180

PORCELÁNICO



| Biorzo Mix 33x67 cm |

BIERZO

30x60 cm / 11,8"x23,6"



Mosaico Bierzo Mix
30x30P (5x5) cm * P180

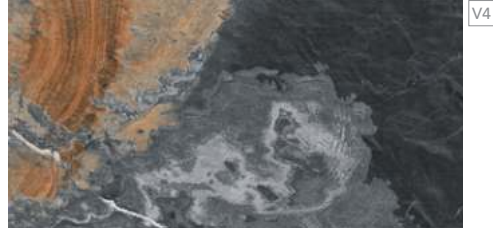

Bierzo Mix
30x60 cm
30x60 cm - Antislip

V4

M185
M185

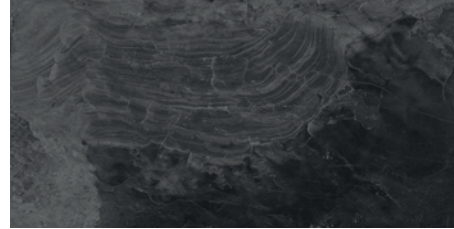

Bierzo Negro
30x60 cm
30x60 cm - Antislip

V3

M185
M185

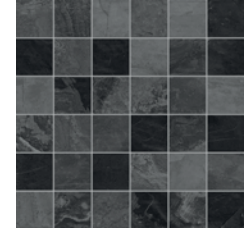

Mosaico Bierzo Negro
30x30P (5x5) cm * P180

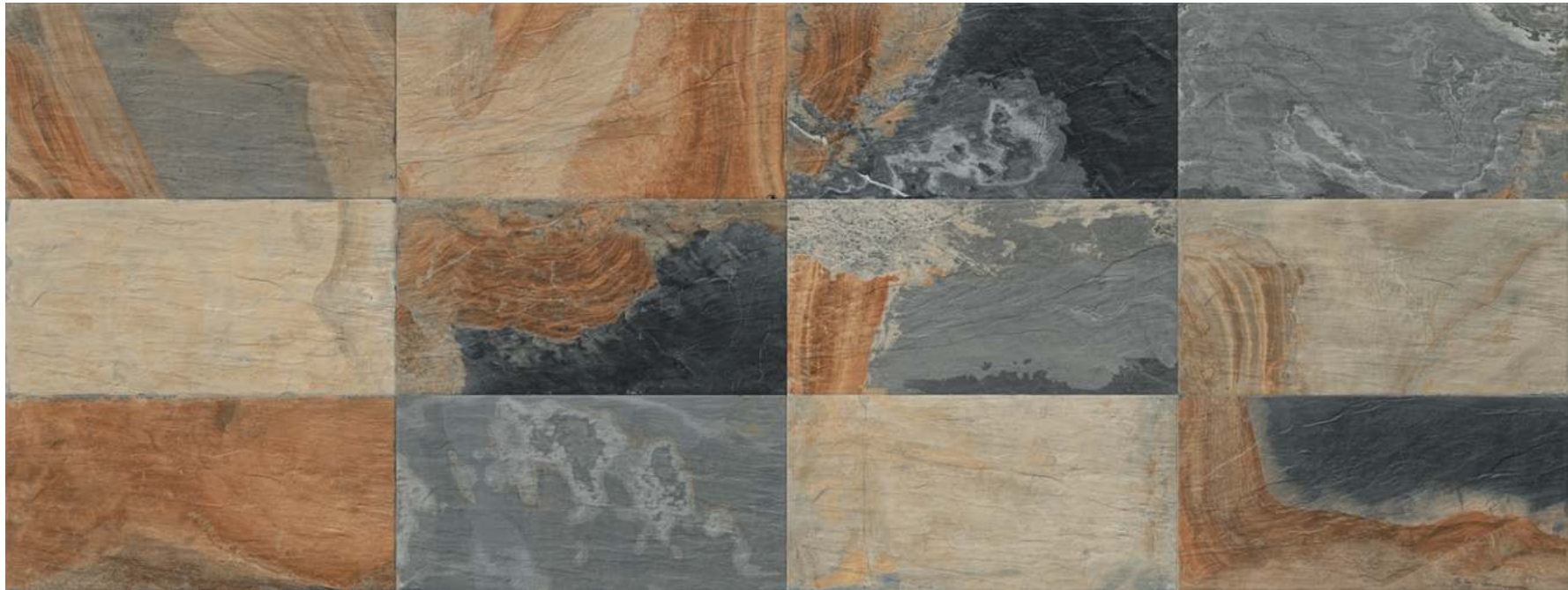

Gráfica Bierzo Mix 33x67



CAMBRIDGE

30x60 cm / 11,8"x23,6"



Cambridge Bone
30x60 cm
30x60 cm · Antislip

M185
M185



Peldaño Extrusionado Cambridge Bone
33x33 cm · Antislip P260



Gráfica Cambridge Bone 30x60

PORCELÁNICO



| New York Beige 33x67 cm |

NEW YORK

30x60 cm / 11,8"x23,6"



New York Beige
30x60 cm · Antislip

M185



New York Musgo
30x60 cm · Antislip

M185



Peldaño Extrusionado New York Musgo
33x33 cm · Antislip P260

*Disponible en 33x33p
Available in 33x33p

PORCELÁNICO



| Portobello Taupe 30x60cm | Peldaño Extrusionado Portobello Taupe 33x33cm |

PORTOBELLO

30x60 cm - 11,8"x23,6"

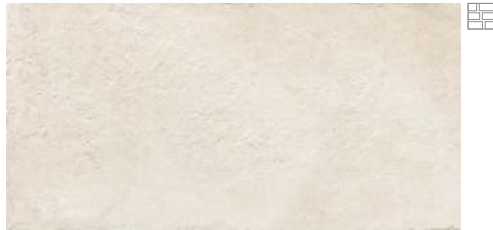

Portobello Ivory
30x60 cm
30x60 cm · Antislip

M185
M185



Portobello Taupe
30x60 cm
30x60 cm · Antislip

M185
M185



Portobello Silver
30x60 cm
30x60 cm · Antislip

M185
M185



Peldaño Extrusionado Portobello Taupe
33x33 cm · Antislip P260

PORCELÁNICO



| Redstone Crema 33x60 cm | Peldaño Extrusionado Redstone Crema 33x33cm |

REDSTONE

30x60 cm / 11,8"x23,6"



Redstone Beige
30x60 cm · Antislip

M185



Redstone Gris
30x60 cm · Antislip

M185



Redstone Crema
30x60 cm · Antislip

M185



Redstone Acero
30x60 cm · Antislip

M185



Peldaño Extrusionado Redstone Beige
33x33 cm · Antislip P260



Peldaño Extrusionado Redstone Crema
33x33 cm · Antislip P260



Peldaño Extrusionado Redstone Gris
33x33 cm · Antislip P260



Peldaño Extrusionado Redstone Acero
33x33 cm · Antislip P260

PORCELÁNICO



| Piedra Natural 23x46 cm |

PIEDRA

23x46 cm / 9"x18,1"



V4

Piedra Natural
23x46cm

A066



V4

Piedra Mix
23x46cm

A066



V3

Piedra Gris
23x46cm

A066

PORCELÁNICO



| Rock Beige 23x46 cm |

ROCK

23x46 cm / 9"x18,1"



Rock Beige
23x46cm

A066



Rock Cuero
23x46cm

A066



Rock Gris
23x46cm

A066



ABADÍA

33x33 cm · SLIM / 13"x13" · SLIM



Abadía Avena
33x33cm · SLIM · T019
33x33cm · SLIM · Antislip T019



Abadía Centeno
33x33cm · SLIM · T019
33x33cm · SLIM · Antislip T019



Peldaño Extrusionado Abadía Avena
33x33 cm · Antislip P260



Peldaño Extrusionado Abadía Centeno
33x33 cm · Antislip P260



ARES

33x33 cm / 13"x13"



Ares Beige
33x33 cm

M073



Ares Cotto
33x33 cm

M073



Ares Acero
33x33 cm

M073



Peldaño Extrusionado Ares Beige
33x33 cm · Antislip P260



Peldaño Extrusionado Ares Cotto
33x33 cm · Antislip P260



Peldaño Extrusionado Ares Acero
33x33 cm · Antislip P260

PORCELÁNICO



| Murta Gris · SLIM · Antislip · 33x33 cm |

MURTA

33x33 cm · SLIM / 13"x13" · SLIM



Murta Beige
33x33cm · SLIM · Antislip T019



Murta Gris
33x33cm · SLIM · Antislip T019



Murta Acero
33x33cm · SLIM · Antislip T019

PORCELÁNICO



| New York Musgo 33x33 cm | Peldaño Extrusionado New York Musgo 33x33 cm |

NEW YORK

33x33 cm / 13"x13"



New York Beige
33x33cm · Antislip M073



New York Musgo
33x33cm · Antislip M073



Peldaño Extrusionado New York Musgo
33x33 cm · Antislip P260



REDSTONE

33x33 cm / 13"x13"



Redstone Beige
33x33cm · Antislip T013



Redstone Crema
33x33cm · Antislip T013



Redstone Gris
33x33cm · Antislip T013

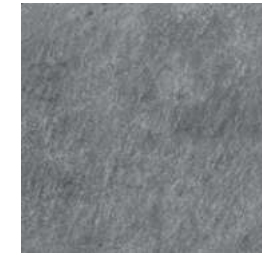

Redstone Acero
33x33cm · Antislip T013



Peldaño Extrusionado Redstone Beige
33x33 cm · Antislip P260



Peldaño Extrusionado Redstone Crema
33x33 cm · Antislip P260



Peldaño Extrusionado Redstone Gris
33x33 cm · Antislip P260



Peldaño Extrusionado Redstone Acero
33x33 cm · Antislip P260

PORCELÁNICO



| Redstone Beige · Antislip 33x33 cm | Peldaño Extrusionado Redstone Beige · Antislip 33x33 cm |

PELDAÑOS

33x33 cm / 13"x13"



Peldaño Extrusionado Ares Acero
33x33 cm · Antislip P260



Peldaño Extrusionado Ares Beige
33x33 cm · Antislip P260



Peldaño Extrusionado Ares Cotto
33x33 cm · Antislip P260



Peldaño Extrusionado Redstone Gris
33x33 cm · Antislip P260



Peldaño Extrusionado Redstone Beige
33x33 cm P260



Peldaño Extrusionado New York Musgo
33x33 cm · Antislip P260



Peldaño Extrusionado Redstone Acero
33x33 cm · Antislip P260



Peldaño Extrusionado Redstone Crema
33x33 cm · Antislip P260



Peldaño Extrusionado Portobello Taupe
33x33 cm · Antislip P260



Peldaño Extrusionado Abadía Avena
33x33 cm · Antislip P260



Peldaño Extrusionado Abadía Centeno
33x33 cm · Antislip P260



Peldaño Extrusionado Cambridge Bone
33x33 cm · Antislip P260

REVESTIMIENTO

WALL TILE

Más información en nuestra web: www.keros.com / For more information: www.keros.com

40X120CM/15.75"X47.24"	
AGORA	98
SUPERWHITE	102
TREND	104

30X90CM/11.8"X25.4"	
ARDENZA	106
CORINTO	108
EXPRESSION	110
LIVORNO	112
LONDON	114
PEONÍA	116
TARENTO	118
TEBAS	120
VERNAZZA	124
WHITE	126

30X60CM/11.8"X23.6"	
ALMA	134
BLANCOS	142
LINK	
LONDON	138
NATURA	140
SOUL	134

20X50CM/7.87"X19.7"	
BLANCOS	142
LAND	144
NATURA	146
VERNAZZA	148

25X75CM/9.8"X29.5"	
CARTAGO	128
CITY	130
WHITE	132

WHITE BODY



| Agora Gris 40x120 cm | Agora Brick Gris 40x120 cm | Banak Gris 23x100 cm |

AGORA

40X120 cm / 15,7"x47,2"



Agora Gris
40x120 cm

M115



Agora Beige
40x120 cm

M115



Agora Brick Gris
40x120 cm

M116



Agora Brick Beige
40x120 cm

M116

WHITE BODY



| Superwhite 40x120 cm | Listelo Metal 1x100 cm

SUPERWHITE

40X120 cm / 15,7"x47,2"

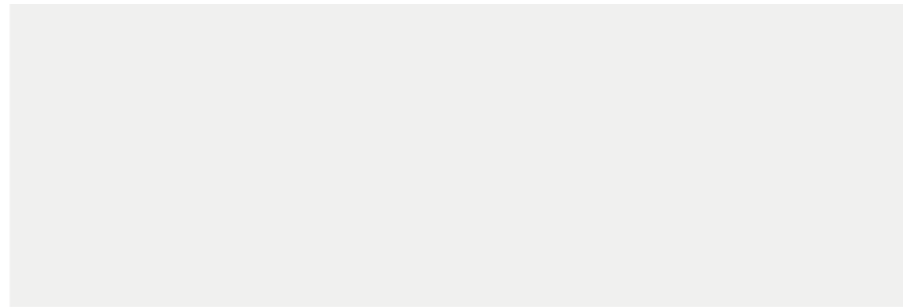

Superwhite
40x120 cm

M115

Listelo Metal
1x100 cm (price per pc)

P135

WHITE BODY



| Trend Gris 40x120 cm | Trend Wave Gris 40x120cm | Bonn Acero 80x80 cm |

TREND

40X120 cm / 15,7"x47,2"



Trend Gris
40x120 cm

M115



Trend Acero
40x120 cm

M115



Trend Wave Gris
40x120 cm

M116

WHITE BODY



| Ardenza Mate 30x90 cm | Ardenza Hexa Mate 30x90 cm |

ARDENZA

30x90 cm / 11,8"x35,4"



Ardenza Brillo
30x90 cm

A098



Ardenza Mate
30x90 cm

A075



Ardenza Lines Brillo
30x90 cm

A099



Ardenza Hexa Mate
30x90 cm

A078

añadir ardenza mate
33x33??? para españa



Ardenza Sea Mate
30x90 cm

A078

WHITE BODY



Colinto Gris 30x90 cm | Colinto Shade Gris 30x90 cm |

CORINTO

30x90 cm / 11,8"x35,4"



Corinto Gris
30x90 cm

A075



Corinto Shade Gris
30x90 cm

A078



Detalle Corinto Shade Gris.



Corinto Sea Gris
30x90 cm

A078

WHITE BODY



| Expression Blanco 30x90 cm | Expression Tri Blanco 30x90 cm |

EXPRESSION

30x90 cm / 11,8"x35,4"

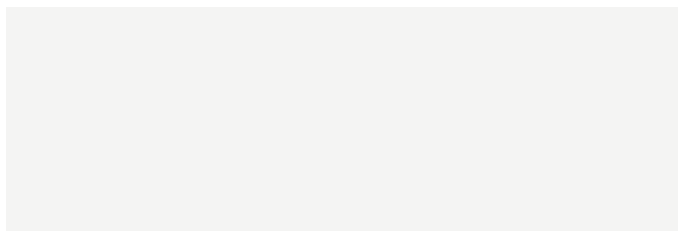

Expression Blanco
30x90 cm

A075

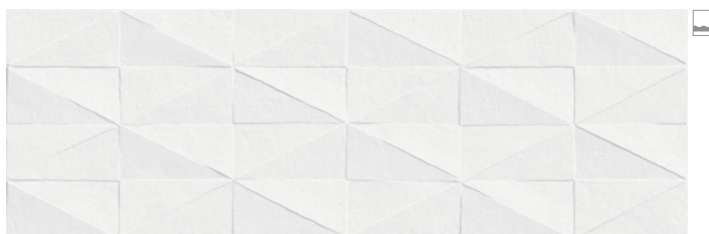

Expression Foro Blanco
30x90 cm

A078



Expression Tri Blanco
30x90 cm

A078

WHITE BODY



| Livorno Gris 30x90 cm | Livorno Lines Gris 30x90 cm |

LIVORNO

30x90 cm / 11,8"x35,4"



Livorno Gris
30x90 cm

A098



Livorno Kentia Gris
30x90 cm

A099



Livorno Lines Gris
30x90 cm

A099

WHITE BODY



| London Gris 30x90 cm | Decorado London Tri Gris 30x90 cm |

LONDON

30x90 cm / 11,8"x35,4"



London Blanco
30x90 cm

A075



Decorado London Tri Gris
30x90 cm

A078



London Gris
30x90 cm

A075



Decorado Lontano Gris
30x90 cm

A078



London Acero
30x90 cm

A075

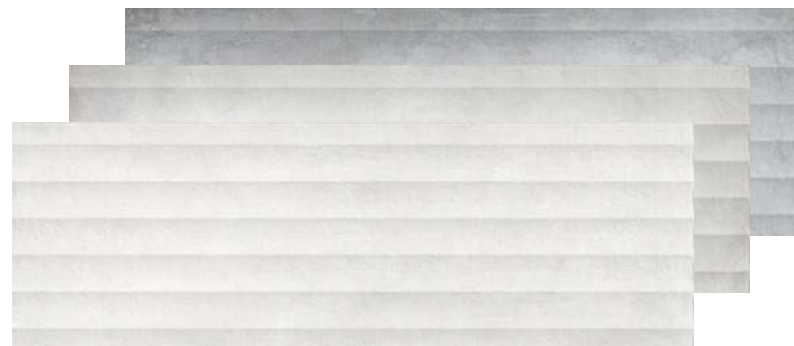

Decorado London Eye Blanco/ Gris/ Acero
30x90 cm

A078



Decorado London Hidráulico
30x90 cm

A078

TE BODY



| Peonia Rosa 30x90 cm | London Blanco 30x90 cm |

PEONIA

30x90 cm / 11,8"x35,4"



Peonia Azul
30x90 cm

A078



Peonia Rosa
30x90 cm

A078

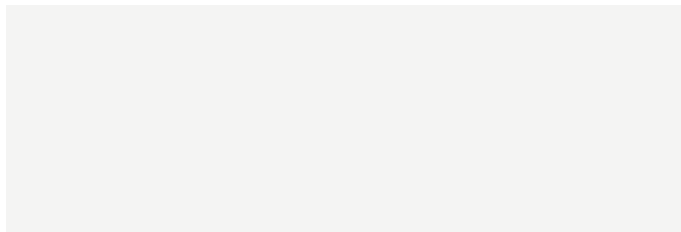

White Mate
30x90 cm

A075



London Blanco
30x90 cm

A075

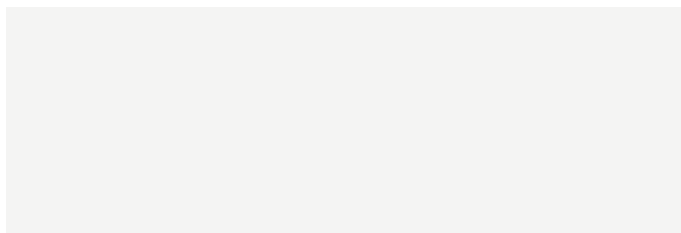

Expression Blanco
30x90 cm

A075

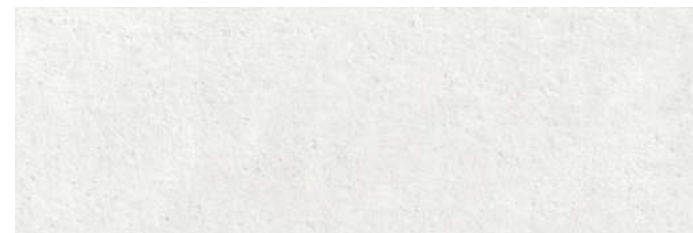

Tarento Blanco
30x90 cm

A075

WHITE BODY



Tarento Gris 30x90 cm | Foro Gris 30x90 cm |

TARENTO

30x90 cm / 11,8"x35,4"



Tarento Blanco
30x90 cm

A075



Decorado Tarento Eye Blanco
30x90 cm

A078

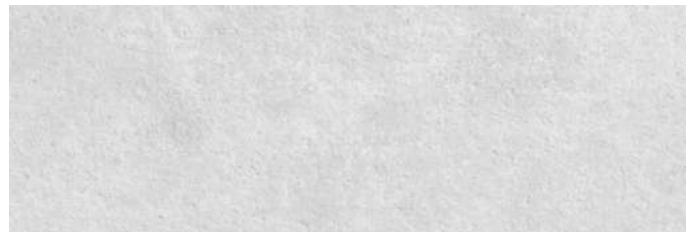

Tarento Gris
30x90 cm

A075



Decorado Lontano Gris / Beige
30x90 cm

A078

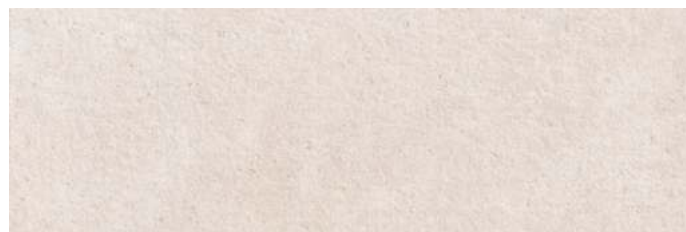

Tarento Beige
30x90 cm

A075



Foro Beige / Gris
30x90 cm

A078

WHITE BODY



| Tebas Gris 30x90 cm | Tebas Mix Gris 30x90 cm |

TEBAS

30x90 cm / 11,8"x35,4"



Tebas Gris
30x90 cm

A075



Tebas Mix Gris
30x90 cm

A078



Tebas Sea Gris
30x90 cm

A078

WHITE BODY



| Ardenza Mate 30x90 cm | Ardenza Hexa Mate 30x90 cm |

THAMES

30x90 cm / 11,8"x35,4"



Thames Gris
30x90 cm

A098

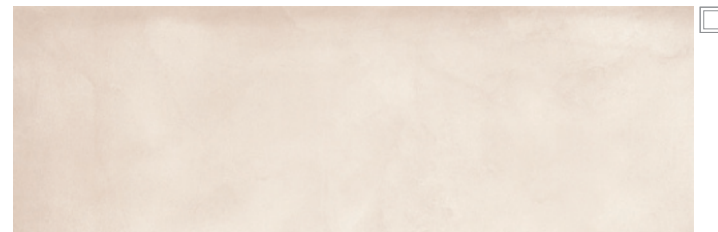

Thames Beige
30x90 cm

A098



Thames Lines Gris
30x90 cm

A099

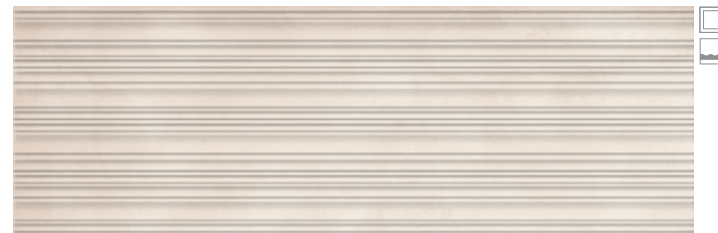

Thames Lines Beige
30x90 cm

A099

WHITE BODY



| Vernazza Negro 30x90 cm | Vernazza Blanco 30x90 cm | Vernaza Doria 30x90 cm | Vernazza Blanco 45x45 cm |

VERNAZZA

30x90 cm / 11,8"x35,4"



Vernazza Blanco
30x90 cm

A075



Vernazza Negro
30x90 cm

A075



Vernazza Doria
30x90 cm

A078



Vernazza Regio
30x90 cm

A078

WHITE BODY



| White Mate 30x90 cm | White Sea Mate 30x90 cm |

WHITE

30x90 cm / 11,8"x35,4"



White Brillo
30x90 cm

A098

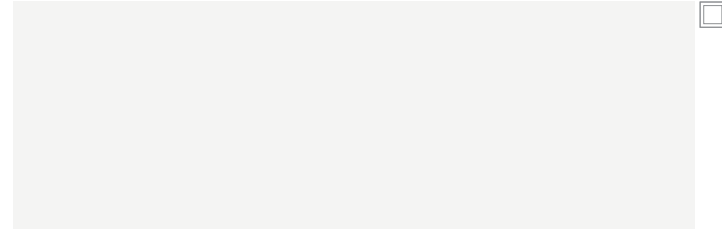

White Mate
30x90 cm

A075

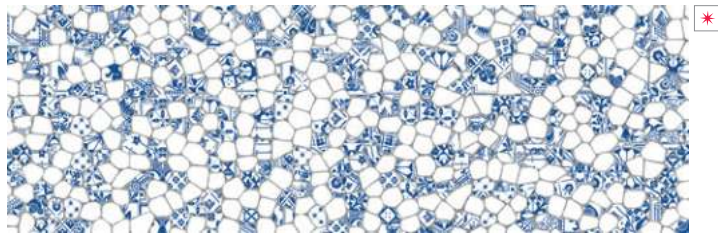

White Gaudí Brillo
30x90 cm

A099

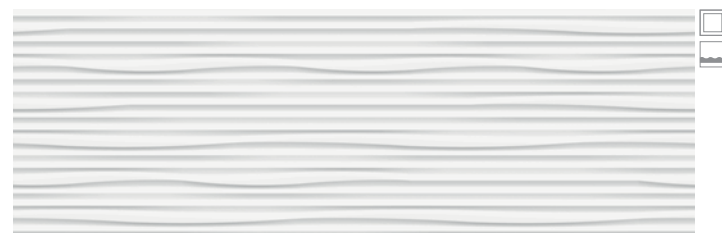

White Sea Mate
30x90 cm

A078



White Lines Brillo
30x90 cm

A099



WHITE BODY

Corpo Beige 25x75 cm | Decorado Cartago Cubik Beige 25x75 cm | Cartago Beige 45x45 cm |

CARTAGO

25x75 cm / 9.8"x29,5"



Cartago Beige
25x75 cm

A068



Cartago Gris
25x75 cm

A068



Decorado Cartago Cubik Beige
25x75 cm

A071



Decorado Cartago Cubik Gris
25x75 cm

A071



Decorado Medina Beige
25x75 cm

A071



Decorado Medina Gris
25x75 cm

A071

cambiar por 33x33??

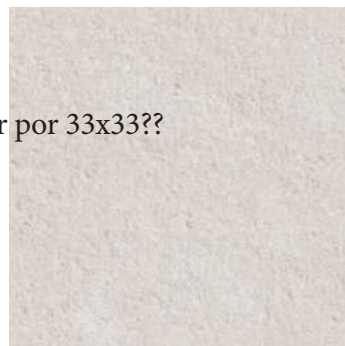

Cartago Beige
45x45 cm

A033

añadir cartago 33x33 para
españa???



Cartago Gris
45x45 cm

A033

WHITE BODY



* City>Beige 25x75cm - Beccardo - Gold - Nero - 3x25 cm - 2x

CITY

25x75 cm / 9.8"x29,5"



City Gris
25x75 cm

A068



Decorado City Dune Gris
25x75 cm

A071



Decorado City Hojas Gris
25x75 cm

A071



City Beige
25x75 cm

A068



Decorado City Dune Beige
25x75 cm

A071



Decorado City Hojas Beige
25x75 cm

A071



City Noce
25x75 cm

A068



Decorado Walk Noce
25x75 cm

A071



City Acero
25x75 cm

A068



Decorado Walk Acero
25x75 cm

A071



City Azul
25x75 cm

A068



Decorado Walk Azul
25x75 cm

A071

cambiar por 33x33 y poner todos los colores en principio serán noce, acero y azul añadir city 33x33 para españa???

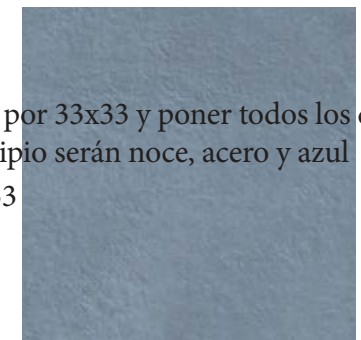

City Azul
45x45 cm

A033



WHITE BODY



| White Mate 25x75 cm | Decorado White Mate Hojas 25x75 cm |

WHITE

25x75 cm / 9.8"x29.5"

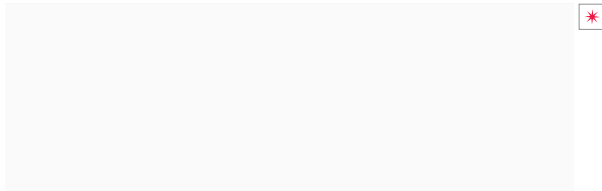

White Liso
25x75 cm

A068

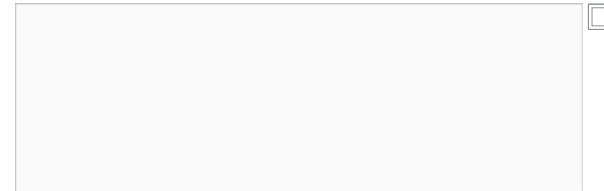

White Mate
25x75 cm

A068



Decorado White Liso Dune
25x75 cm

A071



Decorado White Mate Dune
25x75 cm

A071



Decorado White Liso Hojas
25x75 cm

A071



Decorado White Mate Hojas
25x75 cm

A071

RED BODY



| Alma 30x60 cm | Decorado Alma 30x60 cm |

ALMA

30x60 cm / 11.8"x23.6"



Alma
30x60 cm

T004



Decorado Alma
30x60 cm

T005

SOUL

30x60 cm / 11.8"x23.6"



Soul
30x60 cm

T004

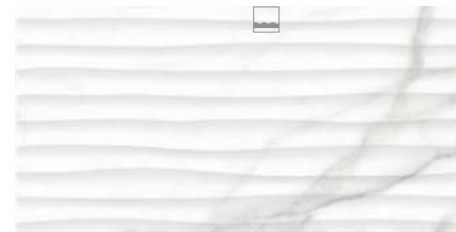

Decorado Soul
30x60 cm

T005

WHITE BODY



| Ardenza Mate 30x60 cm | Ardenza Link Mate 30x60 cm |

ARDENZA

30x60 cm / 11.8"x23.6"



Ardenza Brillo
30x60 cm

A098



Ardenza Mate
30x60 cm

A075



Ardenza Link Brillo
30x60 cm

A???



Ardenza Link Mate
30x60 cm

A???

RED BODY



| London Beige 30x60 cm | Decorado London Hidráulico Beige 30x60 cm |

LONDON

30x60 cm / 11.8"x23.6"



London Beige
30x60 cm

M087



London Gris
30x60 cm

M087



London Blanco
30x60 cm

M087



London Dune Beige
30x60 cm

M088



London Dune Gris
30x60 cm

M088



London Dune Blanco
30x60 cm

M088



Decorado London Hidráulico Beige
30x60 cm

M088



Decorado London Hidráulico Gris
30x60 cm

M088

RED BODY



| Natura Azul 30x60 cm | Natura Gris 30x60 cm | Natura Azul 33x33 cm |

NATURA

30x60 cm / 11.8"x23,6"



Natura Beige
30x60 cm

M087



Natura Gris
30x60 cm

M087



Natura Marrón
30x60 cm

M087



Natura Azul
30x60 cm

M087



Natura Link Beige
30x60 cm

M000



Natura Link Gris
30x60 cm

M000



Natura Link Marrón
30x60 cm

M000



Natura Link Azul
30x60 cm

M000

RED BODY



| Blanco Liso 30x60 cm | Listelo Metal 1x100 cm |

BLANCOS

30x60 cm - 20x50 cm / 11.8"x23.6" - 7.9"x19.7"

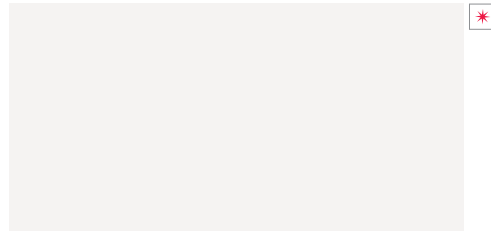

Blanco Brillo
30x60 cm

M021

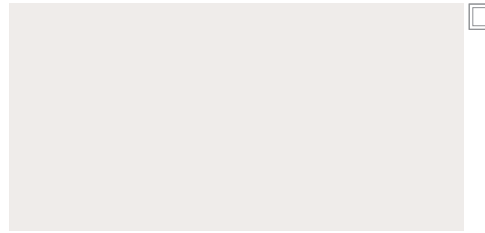

Blanco Mate
30x60 cm

M087



Blanco Dune Mate
30x60 cm

M088

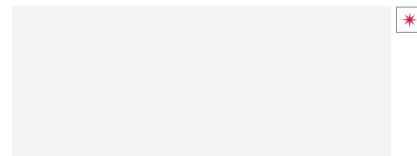

Blanco Brillo
20x50 cm

M078

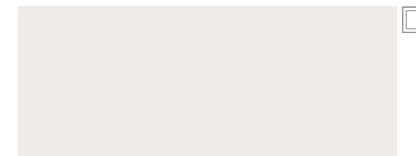

Blanco Mate
20x50 cm

M078

Listelo Metal
1x100 cm (price per pc)

P135

RED BODY



| Land Gris 20x50 cm | Decorado Hidra Gris 20x50 cm | Portland Gris 50x50 cm |

LAND

20x50 cm / 7,9"x19,7"



Land Beige
20x50 cm

M078



Land Gris
20x50 cm

M078



Decorado Hidra Beige
20x50 cm

M015



Land Noce
20x50 cm

M078



Land Acero
20x50 cm

M078



Decorado Hidra Gris
20x50 cm

M015



Decorado Brick Beige
20x50 cm

M015



Decorado Brick Gris
20x50 cm

M015



Decorado Hidra Azul
20x50 cm

M015

RED BODY



| Natura Gris 20x50 cm | Natura Azul 20x50 cm |

NATURA

20x50 cm / 7,9"x19,7"



Natura Beige
20x50 cm

M078



Natura Marrón
20x50 cm

M078



Natura Gris
20x50 cm

M078



Natura Azul
20x50 cm

M078



Decorado Brick Beige
20x50 cm

M015



Decorado Brick Gris
20x50 cm

M015



VERNAZZA

20x50 cm / 7,9"x19,7"



Vernazza Blanco
20x50 cm

M078



Vernazza Negro
20x50 cm

M015



Vernazza Regio
20x50 cm

M015

• CARACTERÍSTICAS TÉCNICAS •

SERIE	FORMATO	COLOR	PEI	MOHS	RES. MANCHAS	RES. ATAQ. QUI-MICO	PÉNDULO (DESLIZAMIENTO)	RAMPA	A-B-C
ABADÍA	33x33/50x50 cm	AVENA,CENTENO	IV	5	5	GA-GLA-GHA	C3	R11	-
ABADÍA-Antislip	33x33 cm	AVENA,CENTENO	IV	5	5	GA-GLA-GHA	-	-	-
ARDENZA	80x80 cm	BRILLO	III	4	5	GA-GLA-GHA	-	-	-
ARDENZA	80x80 cm	MATE	III	5	5	GA-GLA-GHA	-	-	-
ARDENZA GOLD	60x120 cm								
ARES	33x33 cm	BEIGE	IV	6	5	GA-GLA-GHA	C3	R11	-
ARES	33x33 cm	BEIGE	IV	6	5	GA-GLA-GHA	C3	R11	-
ARTESA	50x50 cm	BEIGE	IV	6	5	GA-GLA-GHA	-	-	-
AUGUSTA	50x50/30x60 cm	BEIGE	IV	5	5	GA-GLA-GHA	-	-	-
AUGUSTA-Antislip	30x60 cm	BEIGE	IV	5	5	GA-GLA-GHA	C3	R11	-
BANAK	23x120 cm	BEIGE,BLANCO,GRIS	IV	6	5	GA-GLA-GHA	-	-	-
BIERZO	30x60 cm	MIX,NEGRO	IV	6	5	GA-GLA-GHA	-	-	-
BONN	60x120 cm								
CANADA	80x80 cm	ROBLE	III	7	5	GA-GLA-GHA	-	-	-
CAMBRIDGE	30x60, 50x50 cm	BONE	IV	7	5	GA-GLA-GHA	-	-	-
CAMBRIDGE - Antislip	30x60, 50x50 cm	BONE	IV	6	5	GA-GLA-GHA	C3	R11	-
COTTO	80x80 cm	ACERO,CUERO	III	7	5	GA-GLA-GHA	-	-	-
COTTO	80x80 cm	BEIGE,GRIS	IV	7	5	GA-GLA-GHA	-	-	-
DAFNE	80x80 cm	BEIGE,GRIS	IV	7	5	GA-GLA-GHA	-	-	-
DAFNE	80x80 cm	NEGRO,TAUPE	III	7	5	GA-GLA-GHA	-	-	-
HALIFAX	80x80 cm	-	III	6	5	GA-GLA-GHA	-	-	-
HAYEDO	23x120 cm	ROBLE	III	5	5	GA-GLA-GHA	-	-	-
HAYEDO - Antislip	23x120 cm	ROBLE	III	6	5	GA-GLA-GHA	C3	R11	-
HAYEDO	23x120 cm	ALMOND,GRIS	IV	5	5	GA-GLA-GHA	-	-	-
HAYEDO - Antislip	23x120 cm	ALMOND,GRIS	IV	6	5	GA-GLA-GHA	C3	R11	-
FERRARA	60x120 cm	ACERO							
FERRARA	60x120 cm	BEIGE,GRIS							
LIVORNO GRIS	60x120 cm								
LONDON	80x80 cm	ACERO	III	7	5	GA-GLA-GHA	-	-	-
LONDON	80x80 cm	BEIGE,GRIS	IV	7	5	GA-GLA-GHA	-	-	-
LONDON	80x80 cm	BEIGE,GRIS	IV	7	5	GA-GLA-GHA	-	-	-
MARQUINA NEGRO	60x120 cm		?	?	?	?	?	?	?
ÓNICE SILVER	60x120 cm		?	?	?	?	?	?	?
MODULA ABADÍA	100x100 cm	AVENA,CENTENO	IV	5	5	GA-GLA-GHA	-	-	-
MODULA ABADÍA - Antislip	100x100 cm	AVENA,CENTENO	IV	5	5	GA-GLA-GHA	C3	R11	-
MODULA ARTESA	100x100 cm	BEIGE	IV	6	5	GA-GLA-GHA	-	-	-
MODULA ARTESA - Antislip	100x100 cm	BEIGE	IV	6	5	GA-GLA-GHA	C3	R11	-
MODULA AUGUSTA	100x100 cm	BEIGE	IV	5	5	GA-GLA-GHA	-	-	-
MODULA AUGUSTA - Antislip	100x100 cm	BEIGE	IV	5	5	GA-GLA-GHA	C3	R11	-

• CARACTERÍSTICAS TÉCNICAS •

SERIE	FORMATO	COLOR	PEI	MOHS	RES. MANCHAS	RES. ATAQ. QUI-MICO	PÉNDULO (DESLIZAMIENTO)	RAMPA	A-B-C
MODULA CAMBRIDGE	100x100 cm	BONE	IV	7	5	GA-GLA-GHA	-	-	-
MODULA CAMBRIDGE · Antislip	100x100 cm	BONE	IV	6	5	GA-GLA-GHA	C3	R11	-
MODULA PORTOBELLO	100x100 cm	IVORY,SILVER,TAUPE	IV	7	5	GA-GLA-GHA	-	-	-
MODULA PORTOBELLO · Antislip	100x100 cm	IVORY,SILVER,TAUPE	IV	7	5	GA-GLA-GHA	C3	R11	-
MURTA	33x33 cm	AVENA	IV	7	5	GA-GLA-GHA	C3	R11	-
MURTA	33x33 cm	CENTENO	III	7	5	GA-GLA-GHA	C3	R11	-
NEWYORK · Antislip	33x33, 30x60 cm	BEIGE,MUSGO	IV	7	5	GA-GLA-GHA	C3	-	-
PIEDRA	23x46 cm	MIX	III	7	5	GA-GLA-GHA	-	-	-
PIEDRA	23x46 cm	GRIS,NATURAL	IV	7	5	GA-GLA-GHA	-	-	-
PORTOBELLO	30x60 cm, 50x50 cm	IVORY,SILVER,TAUPE	IV	7	5	GA-GLA-GHA	-	-	-
PORTOBELLO · Antislip	30x60 cm, 50x50 cm	IVORY,SILVER,TAUPE	IV	7	5	GA-GLA-GHA	C3	R11	C
QUEBEC	80x80 cm	BLANCO	III	4	5	GA-GLA-GHA	-	-	-
REDSTONE	33x33 cm, 30x60 cm	ACERO,CREMA	III	7	5	GA-GLA-GHA	C3	-	-
REDSTONE	33x33 cm, 30x60 cm	BEIGE,GRIS	IV	7	5	GA-GLA-GHA	C3	-	-
REDSTONE · Antislip	30x60 cm	ACERO,CREMA, BEIGE,GRIS	III	7	5	GA-GLA-GHA	C3	R11	-
REGINA	80x80 cm	-	IV	5	5	GA-GLA-GHA	-	-	-
ROCK	23x46 cm	BEIGE,CUERO,GRIS	IV	6	5	GA-GLA-GHA	-	-	-
SIA	23x120 cm	ALMOND,BLANCO,MIEL	IV	5	5	GA-GLA-GHA	-	-	-
SIA	23x120 cm	OLIVA	III	5	5	GA-GLA-GHA	-	-	-
SUNROCK	30x60 cm	NEGRO	III	6	5	GA-GLA-GHA	-	-	-
SUNROCK	30x60 cm	BLANCO	IV	6	5	GA-GLA-GHA	-	-	-
TANGRAM ABADÍA	100x100 cm	AVENA,CENTENO	IV	5	5	GA-GLA-GHA	-	-	-
TANGRAM ABADÍA · Antislip	100x100 cm	AVENA,CENTENO	IV	5	5	GA-GLA-GHA	C3	R11	-
TANGRAM ARTESA	50x50 cm	BEIGE	IV	6	5	GA-GLA-GHA	-	-	-
TANGRAM ARTESA · Antislip	50x50 cm	BEIGE	IV	6	5	GA-GLA-GHA	C3	R11	-
TRIBECA	23x120 cm	-	IV	6	5	GA-GLA-GHA	-	-	-
VERNAZZA	80x80 cm	NEGRO	III	6	5	GA-GLA-GHA	-	-	-

• RESERVA DE DERECHO •

Keros aplica una política de continuo desarrollo de sus productos y se reserva el derecho a realizar cambios en los productos, colores, especificaciones técnicas, packing y códigos sin previo aviso.

Keros ha realizado un esfuerzo considerable para que toda la información sea adecuada en el momento de la publicación de catálogo. A causa de las limitaciones del proceso de impresión los colores reproducidos pueden sufrir ligeras variaciones con respecto al producto original. Keros informa que este catálogo tiene validez a nivel informativo y por tanto no se hace responsable de los posibles errores de impresión, reservándose el derecho de realizar modificaciones sin necesidad de preaviso.

Por favor, revise el tono, el calibre y la clase antes de colocar el material. Keros no se hará responsable después de que se coloque el material.

Keros operates a policy of continuous development and reserves the right to make changes to its products, colours, engineering specifications, packaging and codes without prior notice.

Keros has taken every effort to ensure that the information contained in the catalogue is correct at the time of publication. Due to the limitations of the printing process, the colours reproduced may vary slightly from the original product. Keros advises that this catalogue is only valid for information purposes and therefore does not accept responsibility for any possible printing errors.

Please, check shade, caliber and class before placing. Keros will not take responsibility after the material is placed.

• DESTONIFICADO •

Los azulejos pueden variar en color, textura o apariencia según el diseño del fabricante para una serie en particular. La siguiente tabla muestra la clasificación estética para que el fabricante pueda comunicar las características de un producto en concreto. Cualquier pregunta o duda sobre su elección de azulejos debe ser aclarada antes de su instalación.

V2-VARIACIÓN LIGERA.

Las diferencias en textura y/o dibujos con colores son claramente diferenciadas.

V3-VARIACIÓN MODERADA.

Mientras que los colores y/o texturas presentes en una sola pieza serán indicativos de los colores y/o texturas en el resto de piezas, la cantidad de colores y/o texturas en cada pieza pueden variar significativamente. Es recomendable que se muestre toda la gama de colores antes de elegir.

V4-VARIACIÓN SUBSTANCIAL.

Color aleatorio y/o diferencia en textura de una pieza a otra, hasta el punto que una puede tener un color y/o textura diferentes al resto de piezas. Además, la instalación final será única. Se recomienda que se muestre toda la gama antes de elegir.

Tiles may vary in color, texture, or appearance according to the manufacturer's design for that particular tile series of produce line. The following aesthetic class designations have been provided in the Table, so that manufacturer may communicate the aesthetic characteristics of a particular tile product. Any questions or concerns about your tile selection should be clarified prior to installation.

V2- SLIGHT VARIATION.

Clearly distinguishable differences in texture and/or pattern with similar colors.

V3-MODERATE VARIATION.

While the colors and/or texture present on a single piece of tile will be indicative of the colors and/or texture to be expected on the other tiles, the amount of color and/or texture on each piece may vary significantly. It is recommended that the range be viewed before selection.

V4-SUBSTANTIAL VARIATION

Random color and/or texture differences from tile, so that one tile may have totally different color and/or texture from that one other tiles. Thus, the final installation will be unique. It is recommended that range be viewed before selection.



V2 VARIACIÓN LIGERA.
SLIGHT VARIATION.



V3 VARIACIÓN MODERADA.
MODERATE VARIATION.



V4 VARIACIÓN SUBSTANCIAL.
SUBSTANTIAL VARIATION.



• PIEZAS ESPECIALES •



PELDAÑO RECTO EXTRUSIONADO

	FORMATO	CÓDIGO
	33x33 cm	P260

PELDAÑO TÉCNICO

Sin ranura Doble inglete	Con ranura Doble inglete	FORMATO	CÓDIGO
		80x80 cm	P705
		50x100 cm	P725
		50x50 cm	P545
		33x67P	P600
		33x33P cm	P415
		33x33 cm	P400
		23x100 cm (1 ingletes)	P675
		23x100 cm (2 ingletes)	P705
		23x100R cm (1 ingletes)	P695
		23x100R cm (2 ingletes)	P710

cambiar los formatos y comprobar que tengan el mismo código de precio

23x120 y 30x60

PELDAÑO TORELO

	PELDAÑO TORELO	PELDAÑO TORELO ANGULAR
FORMATO	50x50 cm	-
	33x33 cm	P300

Peldaño torelo



Peldaño torelo angular

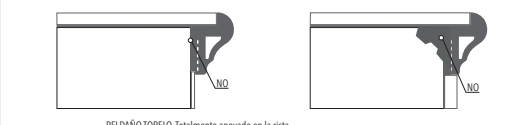

Pegado de un torelo, en la base seleccionada de un proveedor externo y una paleta de colores limitada. El color del torelo pegado no tiene porque ser exacto al color de la base. Intentamos seleccionar el tono más acorde al tono general de la base.

PELDAÑO TORELO. Totalmente apoyado en la rista del soporte.
TORELO STEP. Completely leaning in the edge of the support.

Lecho continuo de mortero adhesivo.
Continuous layer set mortar.

Tabica@luz

1. Colocar el torelo totalmente apoyado en el soporte de la escalera, de modo que tanto la huella como la moldura queden totalmente adheridas y no trabajen en falso.
2. En caso necesario cortar el peldaño a la medida de la huella.
3. Utilizar el mortero adhesivo o cemento cola de buena calidad, en capa continua y bien macizado, evitando que queden huellas.
4. Completar la colocación de la tabica cuando el peldaño este suficientemente firme.

1. Place the torelo-step leaning on the stair support, in order the moulding and tread to be perfectly fixed.
2. If necessary cut the step to the tread-size.
3. Use on thin set mortar or latex cement mortar, in continuous layer and well filled up, avoiding empty hollows.
4. Complete the décor tile inspiration when the step is stable enough.

• PIEZAS ESPECIALES •

INSTRUCCIONES PARA LA COLOCACIÓN Y MANTENIMIENTO

Asegurarse que el soporte estructural esté enrasado y preparado (limpio de polvo, aceites...)

El sentido de colocación será desde abajo hacia arriba (sentido ascendente). (1)

Utilizar herramientas de colocación adecuadas, así como adhesivos específicos para la baldosa y soporte implicados.

Manipular con cuidado.

Colocar todas las huellas, dejando la colocación de las contrahuellas para el final. (1)

La contrahuella debe apoyar sobre la pieza base (primer escalón) o sobre la huella (sucesivos peldaños). (2)

Maestrear la verticalidad sobre la que se coloca la contrahuella hasta el nivel que nos permita, una vez completado el fraguado, colocando en capa fina, llegar al límite exterior de la huella o a la distancia específica para dejar la diferencia de profundidad deseada entre huella y contrahuella. Según el Código Técnico de la Edificación, para escaleras previstas para evacuación ascendente, o las utilizadas preferentemente por niños, ancianos o personas con discapacidad, no se permite bocel ni resalte (huella y contrahuella deben quedar perfectamente alineados), para evitar tropiezos y caídas. (3)

Cortar la contrahuella a la medida establecida para cumplir con el dimensionamiento inicial de la escalera (el Código Técnico de la Edificación establece que para escaleras de uso general, la altura del peldaño debe ser inferior a 18,5 cm y superior a 13 cm, además, la superficie pisable (huella) debe ser superior a 28 cm). (4)

Las baldosas deben quedar perfectamente macizadas, sin huecos, para evitar potenciales fuentes de roturas ó despegues. (2)

Se debe proceder al rejuntado entre las distintas piezas.

Proteger el material ya colocado hasta que finalice la obra, con el fin de evitar daños sobre la superficie cerámica durante los trabajos posteriores.

INSTRUCTIONS FOR INSTALLATION & CARE

Make sure that the substrate is flat and ready for laying the treads (with no dust, oil or grease etc).

Start to lay the treads from the bottom of the staircase (moving upwards). (1)

Use suitable tile-laying tools and the right adhesive for the tiles and substrate.

Handle with care.

Lay all the stair treads before proceeding to lay the risers. (1)

The stair riser of the first step should rest on the bottom floor tile. Subsequent risers should rest on the stair tread below each one. (2)

Level the vertical substrate for each stair riser so that, once the cement has set and the stair riser has been laid using the thin bed method, it reaches the outer edge of the stair tread above it or leaves the desired joint between them. According to the Spanish Building Code, when stairs are used for upward evacuation or mainly used by children, the elderly or the disabled, stair nosings or overhanging treads are forbidden. (The tread and riser must be edge to edge). (3)

Cut the stair riser to the right size to comply with the initial plans for the stairs. (The Spanish Building Code establishes that stairs for general use should have steps with a height of over 13 cm and less than 18,5 cm and that the treads should be bigger than 28 cm). (4)

Bond the tiles solidly, making sure that there are no voids, to prevent them from breaking or coming loose. (2)

Grout the tiles.

Protect the tiled surfaces until all on-site work has been completed in order to prevent them from being damaged during subsequent building tasks.

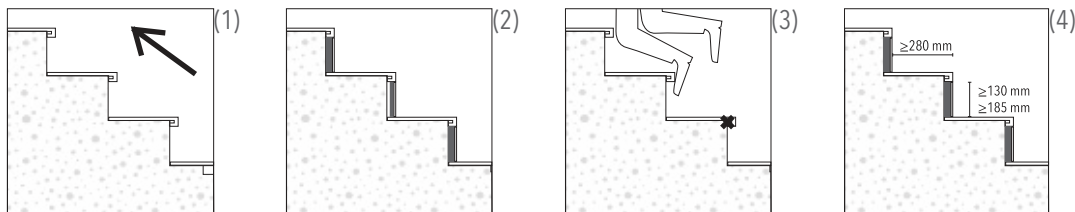

• ANTIDESLIZANTE •

Con el fin de dar una mayor seguridad en aquellas áreas transitables, cuyas condiciones de humedad y pendientes son mayores de lo habitual.

Los productos marcados con nuestra simbología ANTI-SLIP, han sido sometidos a las pruebas de ensayo según las normas UNE-ENV 12633:2003, DIN-51130, DIN-51097 y/o BS 7976-2.

Para más información, consultar con nuestro dpto. técnico.

The aim here is to provide better safety areas of pedestrian traffic, where the humidity conditions and slopes are greater than normal.

This series rates higher than the test results recommended by Regulation UNE-ENV 12633:2003, DIN-51130, DIN-51097 and/or BS 7976-2 .

For more information on this, contact our Technical Department.

DIN 51130	PLANO INCLINADO, PIES CALZADOS INCLINED PLANE, WEARING SHOES
-----------	---

Clasificación de la media corregida conjunta del ángulo crítico para la clasificación antideslizante.
Classification joint adjusted average of critical angle for slip classification.

Clase antideslizante Slip Class	Adherencia Adherence	Ángulo inclinación Slope angle
R9	Normal Normal	De 6° a 10°
R10	Media Medium	> 10° a 19°
R11	Alta High	> 19° a 27°
R12	Fuerte Strong	> 27° a 35°
R13	Muy fuerte Very strong	>35°

CTE	CÓDIGO TÉCNICO DE LA EDIFICACIÓN, SECCIÓN DB-SUA1 VERSIÓN DICIEMBRE 2014
-----	--

CLASE CLASS	Rd	RESISTENCIA AL DESPLAZAMIENTO DISPLACEMENT RESISTANCE
1	15 < Rd ≤ 35	Zonas interiores secas, pendiente <6%. Interior areas that are dry with a grade of <6%.
2	35 < Rd ≤ 45	Zonas interiores secas, pendiente >6%. Zonas interiores húmedas, terrazas, cubiertas, vestuarios duchas, aseos, cocinas etc. Interior areas that are dry with a grade of >6% Interior wet areas, covered terraces, showers, bathroom floor, kitchens, etc.
3	> 45	Zonas con agua, grasas, lubricantes, etc. Zonas interiores húmedas con pendiente > 6%. Zonas exteriores, piscinas. Wet/greasy/lubricated environments. Interior wet areas with a grade of >6%. Exterior areas, swimming pools.

CLASE EXIGIBLE A LOS SUELOS EN FUNCIÓN DE SU LOCALIZACIÓN RATING REQUIRED FOR FLOORING DEPENDING ON ITS LOCATION

LOCALIZACIÓN Y CARACTERÍSTICAS DE SUELO LOCATION AND CHARACTERISTICS OF THE FLOOR	CLASE CLASS
ZONAS INTERIORES SECAS Superficies con pendiente menor que el 6% Superficies con pendiente mayor que el 6% y escaleras DRY INDOOR AREAS Surfaces with a slope of less than 6% Surfaces with a slope equal to or higher than 6% and stairs	1 2 1 2
ZONAS INTERIORES HÚMEDAS, TALES COMO LAS ENTRADAS A LOS EDIFICIOS DESDE EL ESPACIO EXTERIOR (1), TERRAZAS CUBIERTAS, VESTUARIOS, BAÑOS, ASEOS, COCINAS, ETC. : Superficies con pendiente menor que el 6% Superficies con pendiente igual o mayor que el 6% y escaleras INDOOR AREAS SUBJECT TO MOISTURE, SUCH AS ENTRANCES TO BUILDINGS FROM OUTDOOR AREAS (1), COVERED TERRACES AND BALCONIES, CHANGING ROOMS, BATHROOMS, CLOAKROOMS, KITCHENS ETC.: Surfaces with a slope of less than 6% Surfaces with a slope equal to or higher than 6% and stairs	2 3 2 3
ZONAS EXTERIORES.PISCINAS.DUCHAS (2) OUTDOOR AREAS.SWIMMING POOLS.SHOWERS (2)	3 3

(1) Excepto cuando se trate de accesos directos a zonas de uso restringido

(2) En zonas previstas para usuarios descalzos y en el fondo de los vasos, en las zonas en las que la profundidad no exceda de 1.50 m.
Dicha clase se mantendrá durante la vida útil del pavimento

(1) Except for accesses that lead directly to areas of restricted use

(2) In places where users are expected to go barefoot and in the bottom of swimming pools in areas with a depth of less than 1.50 m.
This rating is maintained throughout the useful life of the flooring.

TABLA DE VALORACIÓN DE RIESGO DE DESLIZAMIENTO
SLIP RISK ASSESSMENT TABLE

Locales y áreas de trabajo Remises work areas		VALOR ORIENTATIVO APPROXIMATE VALUE
Entradas y zonas de acceso, incluyendo hoteles, oficinas, edificios públicos, centros comerciales, tiendas, escuelas y guarderías, zonas comunes de edificios públicos, vestíbulos de ascensores internos Entries and access areas including hotels, offices, public buildings, shopping centres, shops, schools and kindergartens, common areas of public buildings, internal lift lobbies	Wet area(1)	R10
	Transitional area	R9
	Dry area	R8 ⁽²⁾
Rampas internas, pendientes (mayores de 1 en 20) - Secas Internal ramps, slopes (greater than 1 in 20) - Dry		R10
Instalaciones totales en oficinas, hoteles, centros comerciales Total facilities in offices, hotels, shopping centres		R10
Puntos de venta de comida rápida, zonas de mostrador de buffet, zona de restauración y zonas de comida rápida en centros comerciales Fast food outlets, buffet food server areas, food court and fast food dining areas in shopping centres		R10
Explanadas cubiertas en estadios deportivos Undercover concourse areas of sports stadium		R10
Balcones privados, no accesibles al público Private, publicly inaccessible balconies		R10
Zonas donde uno mismo se encarga de preparar la comida o pequeñas cocinas Self catering areas or kitchenettes		R10
Zonas de frutas y verduras frescas en tiendas y supermercados Shop and supermarket fresh fruit and vegetable areas		R10
Pasillos de supermercado excepto las zonas de comida fresca Supermarket aisles except fresh fruit areas		R9
Garajes residenciales Residential garages		R10
Cocinas residenciales Residential kitchens		R9
Baños residenciales, baños incorporados, aseos y lavanderías Residential bathrooms, ensuites, toilets and laundries		R9 o A
Hoteles, hospitales e instalaciones para el cuidado de mayores Hotels, hospitals and aged care facilities	Salas y pasillos Wards and corridors	R9
	Con baño incorporado Ensuites	R10 o A
Vuelos de peldaños internos accesibles - con presencia de pasamanos Accessible internal stair nosings - Handrails present	Seco Dry	R10
	Húmedo Wet	R11 o B
Columnatas externas, pasarelas, cruces de peatones, balcones, verandas, cocheras, entradas de coches, patios, forjados de techos, aparcamientos públicos, patios de escuela, zonas de venta externas (por ejemplo, mercados). External colonnade, walkways, pedestrian crossings, balconies, verandas, carports, driveways, court yards and roof decks, public car parks, school yards, external sales areas (e.g. markets).		R11
Caminos privados, accesos primarios al local o edificio, vuelos de peldaños externos Private paths, primary access to premises, external stair nosings		R11
Zonas de servir detrás de las barras de clubes y hoteles públicos, cámaras frigoríficas, congeladores Serving areas behind bars in public hotels and clubs, cold stores, freezers		R11
Rampas externas (incluyendo las entradas de coches, aceras, etc., con -pendiente). Pendiente desde 1 en 20 hasta 1 en 14 External ramps (including sloping driveways, footpaths, etc.); slope of 1 in 20 to 1 in 14		R11



Locales y áreas de trabajo Remises work areas	VALOR ORIENTATIVO APPROXIMATE VALUE
Rampas externas (incluyendo las entradas de coches, aceras, etc., con pendiente). Pendiente con una inclinación mayor de 1 en 14 External ramps (including sloping driveways, footpaths, etc.); slope steeper than 1 in 14	R11
Muelles de carga Loading docks	R11
Cocinas comerciales Commercial kitchens	R11
Vestidores comunitarios Communal changing rooms	A
Playas de piscina y duchas comunitarias Swimming pool surrounds and communal shower rooms	B
Rampas de piscina y escaleras que llevan al agua Swimming pool ramps and stairs leading into water	C

1. Definiciones:
a) Zonas secas - Aquellas zonas en las que las medidas de control apropiadas aseguran que una zona permanezca seca y limpia cuando se usa.
b) Zonas de transición - Aquellas zonas que deben mantenerse secas, por ejemplo mediante la provisión de elementos de diseño (marquesinas, sumideros, esteras, cámaras estancas, etc.) apropiados para la localización física, clima y exposición al agua en general, de acuerdo con su mantenimiento en una condición seca y limpia por el responsable de las instalaciones.
c) Zona húmedas - Aquellas zonas que no se definen como secas o zonas de transición, que pueden estar mojadas, de forma constante o intermitente, o contaminadas de otra forma.
2. La clase R8 es una clasificación artificial que se ha utilizada para indicar productos que no obtienen la clase R9.

1. Definitions:
a) Dry areas – those areas in which appropriate control measures ensure an area remains dry and clean when in use.
b) Transitional areas – those areas that are intended to be kept dry such as by the provision of design features (awnings, drains, mats, air locks, etc.) appropriate to the physical location, climate and general exposure to water, as maintained in a dry and clean condition by the facilities manager.
c) Wet areas – those areas that are not defined as a dry or transitional area, which may be either constantly or intermittently wet or otherwise contaminated.
2. R8 is an artificial classification that has been used to indicate products that fail to obtain class R9.

GUV-I 8527	PLANO INCLINADO, PIES CALZADOS / INCLINED PLANE, WEARING SHOES
------------	---

CLASIFICACIÓN DE LOS RESULTADOS DEL ENSAYO DE LA RAMPA EN MOJADO, DE ANDAR DESCALZO
CLASSIFICATION OF THE RESULTS OF THE TEST OF THE WET RAMP, OF WALKING WITHOUT FOOT

Grupo Group	Ángulo de inclinación mínimo Minimum slope angle	Zonas Zones
A	$\geq 12^\circ$ 	<ul style="list-style-type: none"> -Pasillos de andar descalzo (principalmente secos). -Vestuarios y vestidores comunitarios e individuales. -Suelos de piscinas en zonas donde no se puede nadar, si la profundidad del agua de toda la zona (de una piscina) es más de 80 cm.
B	$\geq 18^\circ$ 	<ul style="list-style-type: none"> -Pasillos de andar descalzo no clasificados en el grupo A. -Locales de duchas. -Playas de piscinas. -En las inmediaciones de las instalaciones de pulverización desinfectante. -Suelos de piscinas en las zonas donde no se puede nadar, donde la profundidad es inferior a 80cm. -Secciones donde no se puede nadar de piscinas con oleaje. -Plataformas elevadoras. -Piscinas para niños pequeños. -Escaleras que llegan al agua. -Escaleras que llegan al agua con un ancho máximo de 1 m y pasamanos en ambos lados. -Escaleras y escaleras fuera de la zona de la piscina. -Escalones y bancos para sentarse y de descanso.
C	$\geq 24^\circ$ 	<ul style="list-style-type: none"> -Escaleras que llegan al agua, si no están clasificadas en el grupo B -Piscinas para caminar. -Bordes de piscina en pendiente.

• LIMPIEZA Y MANTENIMIENTO •

RECOMENDACIONES TÉCNICAS

Para resolver las dudas que en ocasiones surgen en cuanto al mantenimiento y limpieza de materiales y a modo de recomendación, hemos creído oportuno realizar esta guía para que sirva de referencia para nuestro trabajo comercial y a ser posible ayude a resolver las dudas que puedan surgir y a la vez que satisfaga a nuestros clientes. Se controlará por parte del cliente que el material sea destinado al uso correcto. Ante cualquier duda se suspenderá la colocación y formule la consulta o reclamación correspondiente, siempre es mejor asesorarse.

Un simple consejo sirve para prevenir errores y elegir mejor.

LIMPIEZA Y MANTENIMIENTO

LIMPIEZA FINAL DE OBRA:

Después de la colocación es fundamental realizar una buena limpieza para eliminar residuos de junta y en general suciedad de la obra. Para esta operación recomendamos el empleo de un detergente de acción ligeramente ácida que no despidan humos tóxicos y respete las juntas, el material y el usuario, como Fila Deterdek. En el caso de material colocado con junta epoxi o en base resina, se aconseja realizar la limpieza final de obra con un limpiador específico de residuos epoxídicos, como Fila CR10.

MANTENIMIENTO:

Para un buen mantenimiento del pavimento se aconseja el empleo de un detergente neutro con alto poder limpiador como FilaCleaner. En los casos de suciedad intensa e incrustada acumulada en el tiempo, se aconseja consultar el esquema a continuación para encontrar el producto Fila ideal para cada situación.

TECHNICAL RECOMMENDATIONS

In order to solve any question regarding maintenance and/or Cleaning of the goods and as a strongly recommended guidelines, so it may serve as reference to our commercial labour and also our customers would be satisfied. It will be controlled by the customer that the usage of goods will be the right one. Before any doubt, the installation will be stopped and the relative questions or claims must be placed, it is always better learn about first. A simple advice may prevent from making mistakes and will help to choose better.

CLEANING AND MAINTENANCE

CLEANING AFTER LAYING:

Is it crucial to do a good cleaning after the tile laying with the objective to eliminate the joints residues and in general all the building dirt. For this activity we recommend the use of an action detergent with light acid that does not produce toxic fumes and respects the joints, the material and the user, like Fila Deterdek. In the case of epoxy joint or in resin base, the final cleaning is advisable to be made with a specific cleaner called Fila CR10 for epoxy residues.

REGULAR MAINTENANCE:

It is advisable to use a neutral detergent with high cleaning power like Fila Cleaner for a floor tile maintenance. In the cases of intensive and encrusted accumulated dirt it is recommendable to check the table here below to find the appropriate product Fila for each situation.

TIPO DE SUCIEDA INCRUSTADA / TYPE OF DIRTY		PRODUCTO A UTILIZAR / PRODUCT TO USE
Cemento - Cal de agua - Rayas metales - Óxido	Cement - Calcar - Metal tracer - Rust	DETERDEK
Residuos de resina Epoxi	Epoxy residues	FILA CR10
Grasas - Bebidas - Comidas - Goma - Tintes - Rotulador - Gotas de pintura plástica	Greasy - Drinks - Food - Tire marks - Colours - Marker - Etc.	FILA PS/87
Pintadas de grafitis, spray acrílicos, alquídicos y nitro sintéticos.	Grafitis	FILA NOPAINT STAR
Cera de velas - Resinas árboles - Residuos cinta adhesiva	Wax candel - Bitument - Adhesive tape residues	FILASOLV



◆ CONSEJOS DE COLOCACIÓN ◆

1. PREVIO A LA COLOCACIÓN

A la recepción del producto, se deberá verificar que el producto es conforme a lo solicitado, tanto en cantidad como en calidad. Para ello verificaremos que la inscripción de las cajas corresponde con el albarán de entrega de la mercancía.

2. ADECUACIÓN DE LOS PARÁMETROS

Una vez realizada la verificación procederemos a la preparación de la superficie sobre la que se va a instalar el producto elegido.

Para lograr una buena adhesión a la superficie de colocación hay que descubrir su superficie inicial y firme, para lo cual será necesario proceder a una limpieza exhaustiva, ya que la existencia de polvo y de restos de materiales condicionará la correcta adherencia del soporte con el paramento.

Los morteros cola ven reducidas sus prestaciones a partir de los 5 mm de espesor, es por ello que no permite corregir los desniveles del paramento con exceso de adhesivo, por lo que resulta esencial disponer de superficies perfectamente planas.

Para desviaciones mayores de 10 mm sería conveniente aplicar una capa de nivelación para corregirlas.

En la colocación de pavimentos en exteriores habrá que respetar las pendientes necesarias para la eliminación de las aguas.

Antes de la colocación del producto cerámico, en el caso de pavimento, es conveniente replantearnos sobre la superficie ya nivelada algunas piezas para ver el efecto que las mismas presentan.

Para colocaciones modulares, en el momento de la solicitud del pedido, se deberá informar de esta circunstancia, para la asignación de tono y calibre compatible con el modo de colocación elegido.

3. COLOCACIÓN

Dependiendo de la naturaleza del producto cerámico (porcelánico, gres o azulejo) se utilizará el tipo de colocación más adecuado.

La colocación en capa fina, es la técnica de evolución más reciente, apta para cualquier tipo de baldosa y compatible con cualquier soporte.

La colocación se realiza generalmente sobre una capa previa de regularización del paramento, ya sean enfoscados en las paredes o bases de mortero en los suelos.

Existen adhesivos adecuados para cada tipo de soporte, según la norma UNE EN 12004.

En capa fina se utilizan los adhesivos cementosos o morteros cola, las pastas adhesivas y adhesivos de resinas de reacción, con las ventajas de que el tiempo de rectificación es alto y permite una mayor deformabilidad en el soporte y mayor adherencia.

Hay que tener en cuenta que el soporte base suele ser una superficie continua sometida a las contracciones y dilataciones provocadas por los cambios térmicos, movimientos estructurales o la propia retracción del cemento. Por este motivo, una perfecta ejecución de las juntas garantiza que estos movimientos naturales del soporte base no se trasladen a la superficie embaldosada.

4. JUNTAS ESTRUCTURALES

El dimensionado de las juntas estructurales debe detallarse perfectamente en el proyecto de edificación, y deben ser fijadas por el arquitecto o técnico especializado.

Las juntas estructurales entre las baldosas deben llegar hasta el soporte, y su anchura debe ser, como mínimo, la de la junta estructural del soporte.

Las juntas estructurales se rematan llenándolas con materiales de elasticidad duradera.

5. JUNTAS PERIMETRALES

Tienen la misión de aislar el pavimento cerámico, junto con su correspondiente capa de adhesivo, de otras superficies revestidas o pavimentadas como son las uniones pared-suelo o los encuentros con otros elementos constructivos como pilares, ventanas o puertas.

Su misión es evitar que tanto el material cerámico como el adhesivo, tengan contacto con los mencionados elementos, a fin de prevenir la acumulación de tensiones.

Las juntas entre paredes y suelos son siempre necesarias para superficies superiores a 7 m². Se recomienda una anchura de junta de 5 a 10 mm, que quedará oculta por el rodapié, o por el revestimiento.

1. BEFORE FIXING

Upon receiving the product, the product should be checked whether it complies to the order, both in quantity and in quality. To do this, we should verify that the box registration corresponds to the delivery note of the goods.

2. ADJUSTMENT SETTINGS

Once the verification is done, we should proceed to the preparation of the surface on which the chosen product will be installed.

In order to achieve good adhesion to the laying surface the initial and firm surface should be rediscovered and a thorough cleaning is required, since the dust and the material residues will determine the proper adhesion of the support with the facing.

The tile mortars see their benefits reduced from 5 mm thickness, the reason being is that the uneven facing cannot be corrected with additional adhesive, so it is essential to have perfectly flat surfaces.

For larger deviations of 10 mm it would be advisable to apply a leveling layer to correct them.

In laying floors outdoors, the slopes should be taken into consideration for the water removal.

Before placing the ceramic product, in the case of pavement, it is recommendable to put on the leveled surface some tiles to see the produced effect.

Modular placements should be informed at the time of the order so that to provide a suitable tone and a caliber according to the chosen method of tile placing.

3. FIXING

Depending on the nature of the ceramic products (porcelain, stoneware or tile) a special type of placement will be used accordingly.

Placing in thin layer, it is the latest development technique, suitable for any type of tile and compatible with any support.

Placement is usually done on a previously leveled facing layer, whether on plastered walls or mortar bases in floors.

There are suitable adhesives for each type of support according to the UNE EN 12004.

The cementitious adhesives or adhesive mortars, adhesives and reaction resin adhesives are used in thin layer, with the advantage of higher adjustment time, greater deformability in the support and better adhesion.

You should keep in mind that the support base is usually a continuous surface subjected to contraction and expansions caused by temperature changes, structural movement or retraction of the cement itself. Therefore, a perfect execution of the joints ensures that these natural movements of the support base would not move to the tiled surface.

4. STRUCTURAL JOINTS

The sizing of the structural joints must be detailed fully in the building project, and should be fixed by the architect or specialist.

Structural joints between tiles must reach the support, and its width should be at least that of the structural joint stand.

Structural joints are finished filling them with permanently elastic materials.

5. PERIMETER JOINTS

Their objective is to insulate the floor tiles, along with the corresponding adhesive layer, from other covered or paved surfaces such as wall-floor connections or meeting points with other construction elements such as pillars, windows or doors.

Its mission is to prevent both the ceramic material as well as the adhesive from getting into contact with the mentioned elements, in order to prevent the accumulation of tensions.

The joints between walls and floors are always needed for surfaces bigger than 7 m². Sealing width of 5 to 10 mm is recommended, which is hidden by a baseboard, or cladding.

Las juntas perimetrales deben estar convenientemente ejecutadas y funcionar como tales, es decir, deben estar limpias de restos de materiales de obra y llegar hasta el soporte base, por lo que deben preverse antes de colocar la capa de regularización o de lo contrario resultará imposible ejecutarlas correctamente.

La mala ejecución u omisión de las juntas perimetrales es una de las causas más frecuentes del levantamiento de baldosados.

6. JUNTAS DE DILATACIÓN

Tienen por objeto permitir las deformaciones diferenciales originadas por las variaciones térmicas entre las baldosas, la capa de adhesivo, y el soporte.

La anchura mínima será de 5 mm y deben estar convenientemente ejecutadas y funcionar como tales, es decir, deben ser flexibles, impermeables, bien adheridas y deben llegar hasta el soporte.

7. JUNTAS DE COLOCACIÓN

Las juntas de colocación ejercen una importante función estética, realzan la belleza propia de las baldosas cerámicas y compensan sus pequeñas variaciones dimensionales.

Implican la mutua separación repetida regularmente entre las baldosas individuales, recomendándose el empleo de crucetas y cuñas para conseguir una perfecta alineación de las baldosas y la constancia del espesor de las juntas.

Contribuyen a absorber las deformaciones producidas por el soporte y moderan las tensiones que se generan cuando son sometidas a carga. Si las piezas se colocan a tope o hueso, y por tanto, no existe la acción moderadora de las juntas, las tensiones acumuladas pueden llegar a producir el levantamiento de las baldosas.

Son especialmente necesarias cuando baldosas rectangulares se colocan TRABADAS o en ESPIGA, ya que minimizan las cejas que esta técnica de colocación genera. Existe en el mercado una amplia variedad de materiales de rejuntado, que permiten adecuarse a diversos tipos de baldosas y ambientes. Como norma general se recomiendan materiales del tipo J2 según especificaciones de la norma europea EN 12004.

La colocación sin juntas es desaconsejable desde cualquier punto de vista técnico por los riesgos que supone de producir estados patológicos en los recubrimientos.

Como norma general se recomienda la colocación con junta de 3 ó 4 mm, y en ningún caso debiera ser inferior a 2.0 mm.

La colocación trabada o en espiga requiere juntas mínimas de colocación entre baldosas de 5.0 mm.

Para rejuntar baldosas de gres porcelánico no deben elegirse productos coloreados con "negro de humo" (carbón micronizado), ya que su empleo podría impedir la limpieza de la superficie revestida, especialmente cuando se trata de modelos de tonos claros y de producto pulido.

8. SISTEMAS DE NIVELACIÓN

Para lograr una colocación totalmente plana en pavimentos cerámicos, se aconseja el uso de calzos y cuñas autonivelantes. Este sistema además de nivelar las baldosas adyacentes, reduce los tiempos de reposo y colocación de las piezas cerámicas.

Está especialmente recomendado para la instalación de pavimentos y revestimientos con junta mínima, así como para la colocación de pavimentos cerámicos de gran formato y revestimientos rectificadas.

No se admitirán reclamaciones de material colocado en el que no se hayan seguido las recomendaciones de colocación.

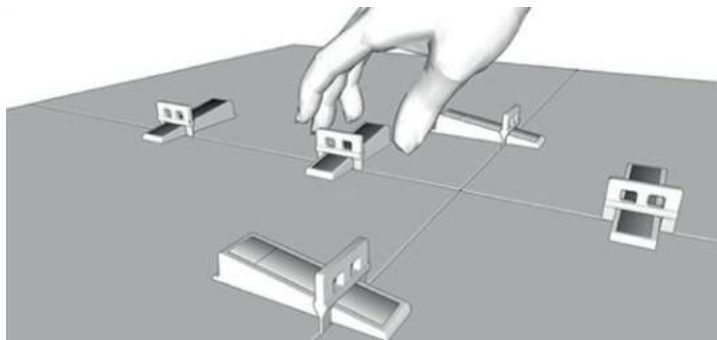

The perimeter joints must be properly done and function as such, meaning, they must be free of building materials residues and reach the base support, which must be taken into consideration before placing the leveling layer otherwise it would be impossible to execute it correctly.

Improper performance or omission of perimeter joints is one of the most common causes of lifted tiles.

6. EXPANSIÓN JOINTS

They are intended to allow the differential deformations caused by thermal variations among the tiles, the adhesive layer and the support.

The minimum width is 5 mm and must be properly implemented and function as such, meaning they must be flexible, waterproof, well bonded and should be able to reach the support.

7. INSTALLATION JOINTS

Installation joints play an important aesthetic function, enhance the inherent beauty of the ceramic tiles and compensate for their small size variations.

Repeated regularly involve mutual spacing between the individual tiles, recommending the use of spreaders and wedges for a perfect alignment of the tiles and the constancy of the joints thickness

They contribute to absorb the deformations produced by the support and moderate the tension generated when subjected to load. If the pieces are laid out without any joints, the accumulated tensions can produce tiles lifting, since there is no moderating action of the boards.

They are necessary in particular, when rectangular tiles are placed in a brick pattern or herring bone layout, as they minimize the eyebrows generated by this placement technique. There is a wide variety of grouts in the market, allowing adaptation to different types of tiles and environments. As a general rule J2 type materials are recommended according to specifications of the European standard EN12004.

Placement without any joints is inadvisable from any technical point of view due to the risks to produce pathological states in the coatings.

As a general rule, the recommended placement is with a joint from 3 to 4 mm, and in no case should be less than 2.0 mm.

The brick pattern or the herring bone pattern layout requires a minimum joint width of 5.0 mm. between the tiles.

For jointing porcelain tiles it is advisable not to choose products colored with "black smoke" (micronized coal), because they could prevent the coated surface from cleaning, especially when it comes to models of light colors and polished products.

8. LEVELLING SYSTEM

To achieve a complete flat laying on ceramic floor tiles, we advise the use of auto leveling systems. This system, besides leveling the adjacent tiles, reduces the time of ceramic tile setting as well.

It is specially recommended for wall tiles and floor tiles installation with a minimum joint, as well as for big size porcelain tiles and rectified wall tiles.

No claims of tiles already installed will be accepted if the installation recommendations have not been taken into consideration.

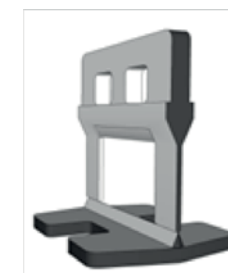

• DIFERENTES COLOCACIONES DE LA SERIE MODULA •



Modulo 1 Modula Abadía Centeno



Modulo 2 Modula Abadía Centeno



Modulo 3 Modula Abadía Centeno



Modulo 4 Modula Abadía Centeno



Modulo 5 Modula Abadía Centeno



Modulo 6 Modula Abadía Centeno



Modulo 7 Modula Abadía Centeno

• DIFERENTES COLOCACIONES DE LA SERIE TANGRAM •



Modulo 1 Tangram Abadía Avena



Modulo 2 Tangram Abadía Avena



Modulo 3 Tangram Abadía Avena



Modulo 4 Tangram Abadía Avena



Modulo 5 Tangram Abadía Avena



Modulo 6 Tangram Abadía Avena



Modulo 7 Tangram Abadía Avena

KEROS

Más información en nuestra web: www.keros.com / For more information: www.keros.com

